

VALORIZZIAMO IL SERRAMENTO

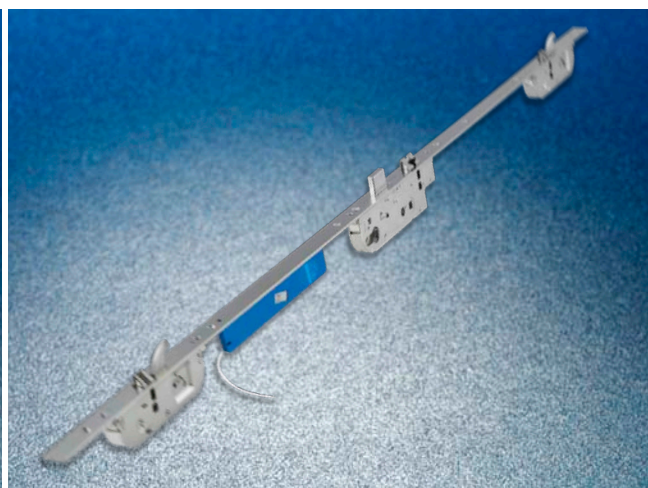

MACO PROTECT

SERRATURE



Catalogo - Italia 2019 | LEGNO + PVC

**MACO
PROTECT**



**MACO
PROTECT**



1	Informazioni tecniche e generali	5
<hr/>		
2	Serratura autobloccante (A-TS)	11
<hr/>		
3	Serratura automatica comando cilindro (Z-TF)	21
<hr/>		
4	Serratura comando cilindro modulare (Z-TS)	29
<hr/>		
5	Serratura comando maniglia prolungabile (G-TS)	41
<hr/>		
6	Serratura per portafinestra (B-TV)	45
<hr/>		
7	Scontri	49
<hr/>		
8	Asta a leva	77
<hr/>		
9	Catenacci	85
<hr/>		
10	Accessori	91
<hr/>		
11	Dime	105
<hr/>		
12	Indice articoli	
<hr/>		

N°	Codice articolo		Uscita puntale
	Confezione unitaria		Larghezza puntale
€	Prezzo lordo in €(/00 significa che il prezzo si riferisce a 100 pezzi)	G-TS =	Serratura comando maniglia
	Interasse	Z-TS =	Serratura comando cilindro
	Entrata maniglia	Z-TF =	Serratura automatica comando cilindro
	Misura quadro	Z-TA =	Serratura autobloccante
	Altezza maniglia (HM)	Z-RS =	Serratura Z-RS scrocco-mandata
	Altezza battente in battuta HBB (da-a)	MF =	Scrocco multifunzione
	Frontale	ZS =	Serratura supplementare
L	Lunghezza	B-TV =	Serratura per portafinestra
	Quantità funghi	MM =	Multi-Matic
	Larghezza battente in battuta LBB (da-a)	U =	Frontale-U
	Lunghezza catenaccio	PZ	Cilindro
B	Larghezza	RZ	cilindro tondo
H	Altezza	i.S. =	Fungo
	Misure scontro scrocco mandata ad angolo	VZ =	nottolino
	Altezza frontale davanti	HO =	Gancio verso l'alto
	Altezza frontale dietro	BO =	Punzone
	Misura di taglio	HO-BO =	Combinazione gancio - punzone
	Raggiatura estremità del catenaccio	MF-BO =	Combinazione scrocco - punzone
		MF-HO =	Combinazione scrocco - gancio
		SFG =	Asta a leva
		EV =	Terminale
		K+ =	Posizione scatola serratura al di sopra dell'altezza maniglia

Nota: Quando non indicato diversamente, le misure sono in mm ed il contenuto delle confezioni in numero di pezzi

1 Informazioni tecniche e generali

1.1 Norme sulla responsabilit  del produttore

Programma serrature MACO PROTECT

Osservare le informazioni di seguito riportate relative al sistema di serrature per porte MACO PROTECT. La mancata osservanza di tali indicazioni solleva il produttore da qualsiasi responsabilit  civile nei confronti di terzi.

1. Informazioni sul prodotto e uso corretto

Il sistema di serrature per porte comprende, per definizione, la ferramenta (su anta e telaio) necessaria per porte in legno, PVC, alluminio e relative combinazioni. Le serrature per porte hanno le seguenti funzioni di base:

- a) chiudere la porta (mantenere la porta chiusa mediante lo scrocco) e
- b) bloccare la porta (serrare la porta con la mandata).

Tutte le serrature per porte Maco sono caratterizzate da una chiusura multipunto e possono essere impiegate nei sistemi di chiusura per porte a montaggio verticale. La gamma di serrature per porte Maco propone due sistemi di serrature dal diverso funzionamento:

1.1. Serratura comandata con maniglia

Il sistema comandato con maniglia consente di chiudere e serrare la porta mediante lo spostamento della maniglia verso l'alto che aziona la fuoriuscita dei punti di chiusura. Una volta chiusa la porta, la serratura viene bloccata mediante una rotazione di 360° della chiave. La maniglia non pu  pi  essere spostata verso il basso e i punti di chiusura sono bloccati. Invertendo la rotazione della chiave nel cilindro, il sistema comandato con maniglia viene nuovamente sbloccato e i punti di chiusura non sono pi  bloccati. Spingendo la maniglia verso il basso, i punti di chiusura e lo scrocco rientrano consentendo l'apertura della porta.

Importante: nella serratura comandata con maniglia devono essere montate sia la maniglia esterna che quella interna!

1.2. Serratura comandata con cilindro

Il sistema comandato con cilindro consente di serrare la porta, dopo che   stata chiusa, mediante due rotazioni di 360° della chiave nel cilindro che fanno penetrare i punti di chiusura negli scontri bloccando la porta. Facendo compiere alla chiave due giri in senso inverso alla chiusura, il sistema viene sbloccato. Per aprire la porta lo scrocco pu  essere fatto rientrare sia muovendo la maniglia che ruotando la chiave nel cilindro. Nelle serrature comandate con cilindro   possibile montare un pomolo sul lato esterno della porta. Le serrature multipunto Maco possono essere montate in combinazione con i cilindri reperibili in commercio conformi alla norma DIN 18254. Le scatole della serratura sono conformi alla norma DIN 18251. In casi particolari chi installa una serratura Maco deve accertarsi che

il cilindro scelto sia adatto alla prevista serratura e possa garantire una buona funzionalit .

2. Montaggio

Le serrature multipunto MACO possono essere montate solo da personale specializzato. Le serrature per porte MACO devono poter essere inserite senza difficolt  nelle fresate della cava ferramenta previste per il montaggio delle scatole serratura e delle chiusure con gancio e a scrocco/punzone. L'inserimento forzato dei componenti nelle fresate potrebbe pregiudicare la funzionalit  dell'intera serratura. Per avvitare il frontale nella cava utilizzare solo utensili adatti (strumenti torsionometrici). Gli scontri (standard, antieffrazione, per chiusura a gancio e a punzone) devono essere montati in modo da consentire la chiusura dei punti di chiusura senza alcuna difficolt  e far s  che i punti di chiusura, una volta che sono completamente fuoriusciti, non penetrino nello scontro fino alla battuta. Per il corretto montaggio del prodotto ogni frontale e il rispettivo scontro sono dotati di tacche che facilitano l'esatto posizionamento dello scontro rispetto al frontale. Le serrature multipunto Maco possono essere montate in molti tipi di portoncini e porte secondarie tenendo presente che questi componenti non sono in grado di adattarsi a deformazioni o variazioni della chiusura della porta causate da sbalzi di temperatura o cambiamenti strutturali.

3. Uso non conforme ed errato

I disegni sulle prossime pagine mostrano i casi di uso errato e uso non conforme.

4. Manutenzione

Per garantire il perfetto funzionamento delle serrature multipunto MACO PROTECT,

fornire a montatori ed illustratori le necessarie informazioni e istruzioni;

osservare le normative vigenti in materia;

utilizzare le serrature multipunto MACO rispettando le funzioni a cui sono preposte;

osservare tassativamente le indicazioni del produttore relative alla composizione della ferramenta;

seguire le istruzioni per la manutenzione e la cura;

far eseguire interventi di riparazione solo da personale specializzato.

5. Prestazioni

Per qualsiasi applicazione non riportata nei nostri cataloghi e prospetti, rivolgersi ai tecnici Maico.

I dati relativi alle prestazioni dei prodotti sono riferiti esclusivamente alla combinazione di componenti originali Maco.



La funzionalità dei sistemi di chiusura dipende dalla frequenza e dalle modalità di utilizzo, dalle condizioni ambientali e dalla manutenzione eseguita.

6. Sezioni

In base al tipo di lavorazione adottata si sceglie la serratura con le caratteristiche più appropriate.

Attenzione: Rispettare le quote indicate per lo scostamento della cava ferramenta al fine di garantire un ottimale funzionamento della serratura.

1.2 Soluzione innovativa - il frontale a "T"

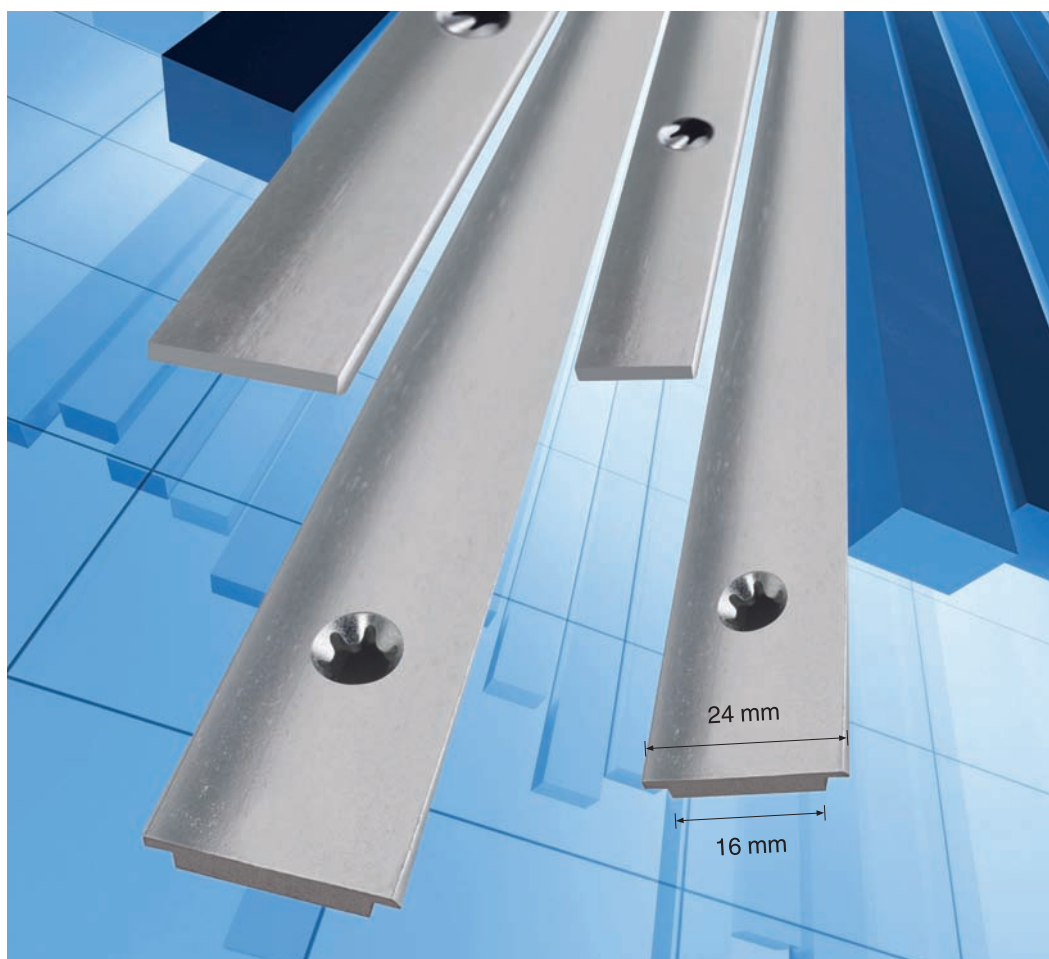

L'evoluzione tecnica del frontale

Vantaggi

- La sicurezza e le caratteristiche estetiche del frontale piatto di 24 mm abbinato a una cava ferramenta da 16 mm
- Nessun deposito di sporco nell'intercapedine tra frontale e cava ferramenta
- La larghezza di 24 mm assicura la copertura delle eventuali imprecisioni dovute agli scassi per l'alloggiamento delle scatole
- Maggiore robustezza rispetto al frontale da 16 mm
- Semplicità di montaggio e posizione delle viti identica a quella dei frontali standard

Vantaggi del frontale a T

Nessun deposito di sporco nell'intercapedine tra frontale e cava ferramenta

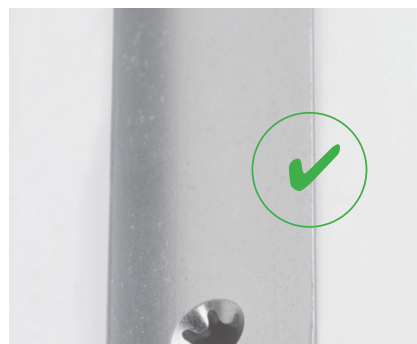

La larghezza di 24 mm assicura la copertura delle eventuali imprecisioni dovute agli scassi per l'alloggiamento delle scatole

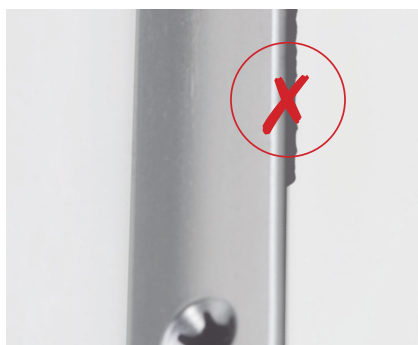

Nessuna riduzione dell'aria

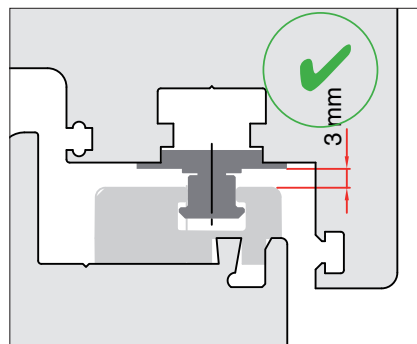
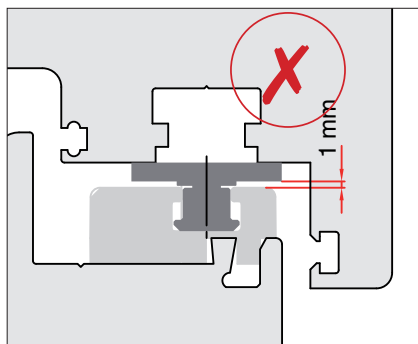

1.3 Sezioni di profilo

Profili in legno

Aria 4 mm

Frontale 16 mm

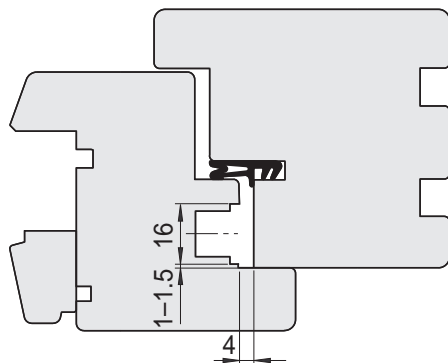

Aria 12 mm

Frontale 16 mm

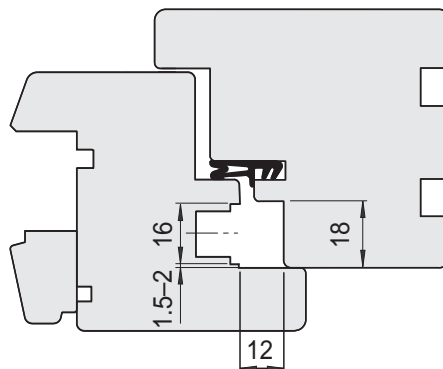

Aria 4 mm

Frontale 20 mm

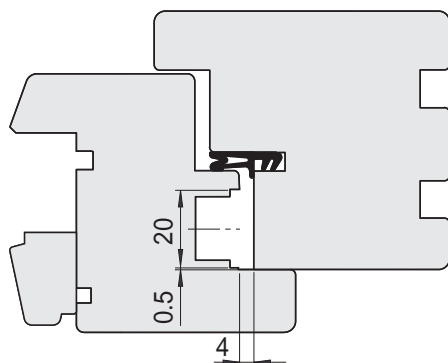

Aria 12 mm canalino Euro

Frontale 16 mm

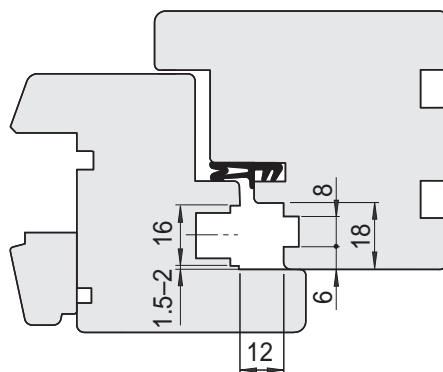

Profili in PVC

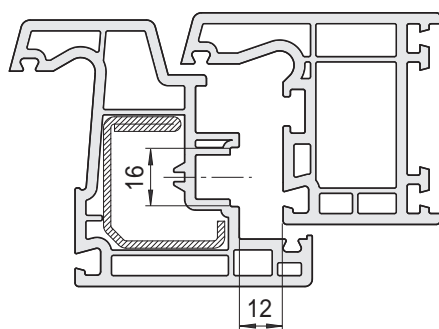

Profili in alluminio

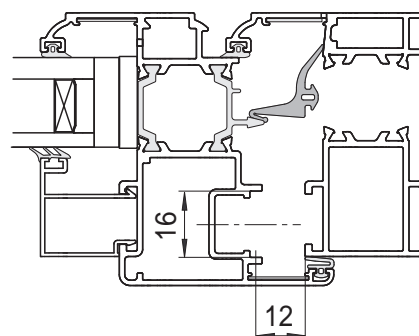





2 Serratura autobloccante (A-TS)

2.1	Composizione ferramenta serratura autobloccante	12
2.2	Serratura autobloccante con 2 scrochi - 2 ganci	17
2.2.1	Serratura autobloccante I85 con 2 scrochi - ganci F16	17
2.2.2	Serratura autobloccante I85 con 2 scrochi - ganci F16 K+605	17
2.2.3	Serratura autobloccante I85 con 2 scrochi - ganci F16 K+980	17
2.2.4	Serratura autobloccante I85 con 2 scrochi - ganci F20	18
2.2.5	Serratura autobloccante I85 con 2 scrochi - ganci F20 K+605	18
2.2.6	Serratura autobloccante I85 con 2 scrochi - ganci F20 K+980	18
2.2.7	Serratura autobloccante I85 con 2 scrochi - ganci F24	18
2.2.8	Serratura autobloccante I85 con 2 scrochi - ganci F24 K+605	19
2.2.9	Serratura autobloccante I85 con 2 scrochi - ganci F24 K+980	19
2.2.10	Serratura autobloccante I85 con 2 scrochi - ganci F24/16	19
2.2.11	Serratura autobloccante I85 con 2 scrochi - ganci F24/16 K+605	19
2.2.12	Serratura autobloccante I85 con 2 scrochi - ganci F24/16 K+980	20
2.2.13	Serratura autobloccante I85 con 2 scrochi - ganci U-6x24x6	20
2.2.14	Serratura autobloccante I85 con 2 scrochi - ganci U-6x24x6 K+980	20
2.2.15	Serratura autobloccante I85 con 2 scrochi - ganci U-6x24x6 K+605	20

2 Serratura autobloccante (A-TS)

2.1 Composizione ferramenta serratura autobloccante

① Prolunga

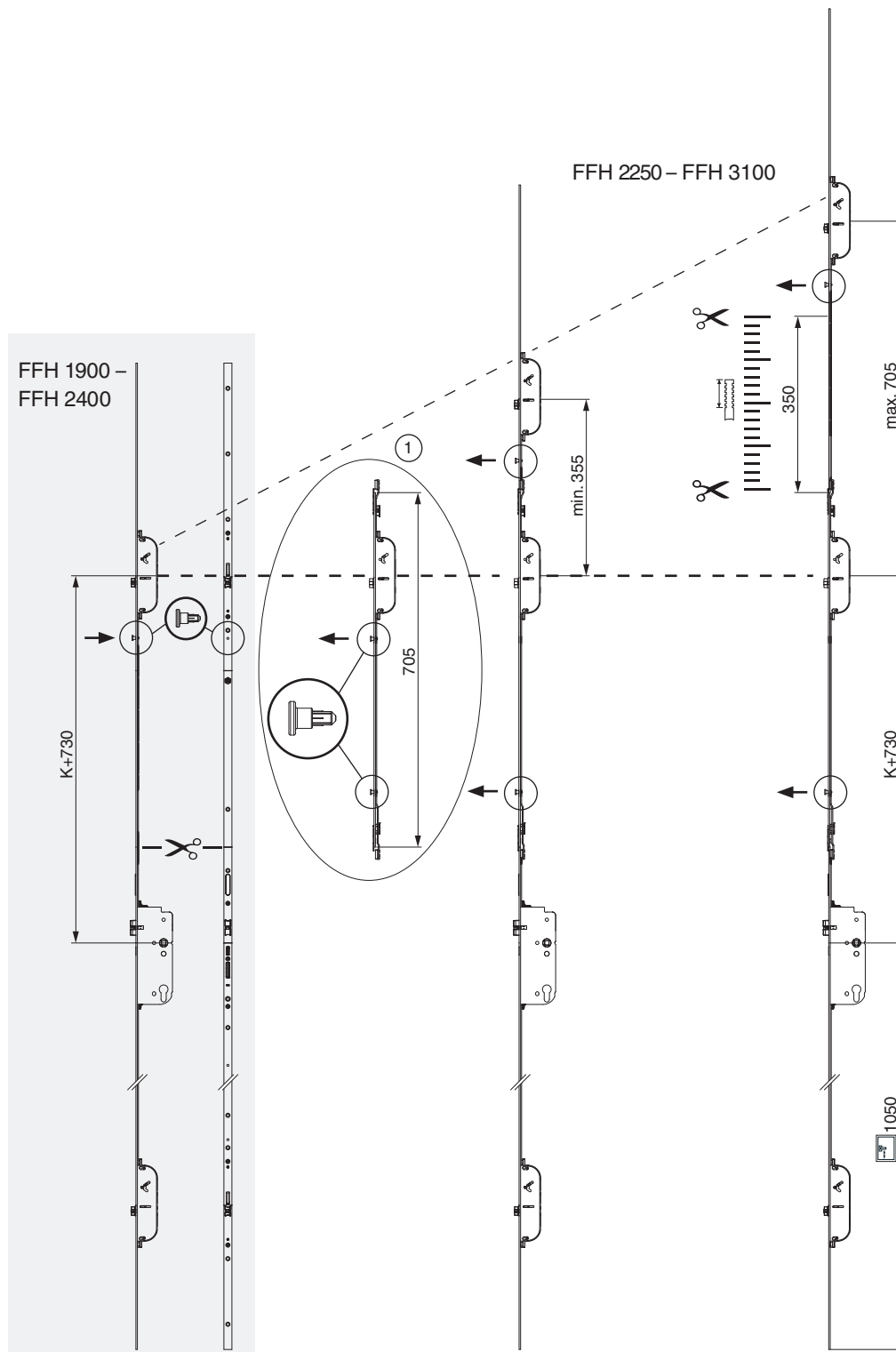

- ① Giunzione accorciamento serratura
- ② Prolunga per serratura

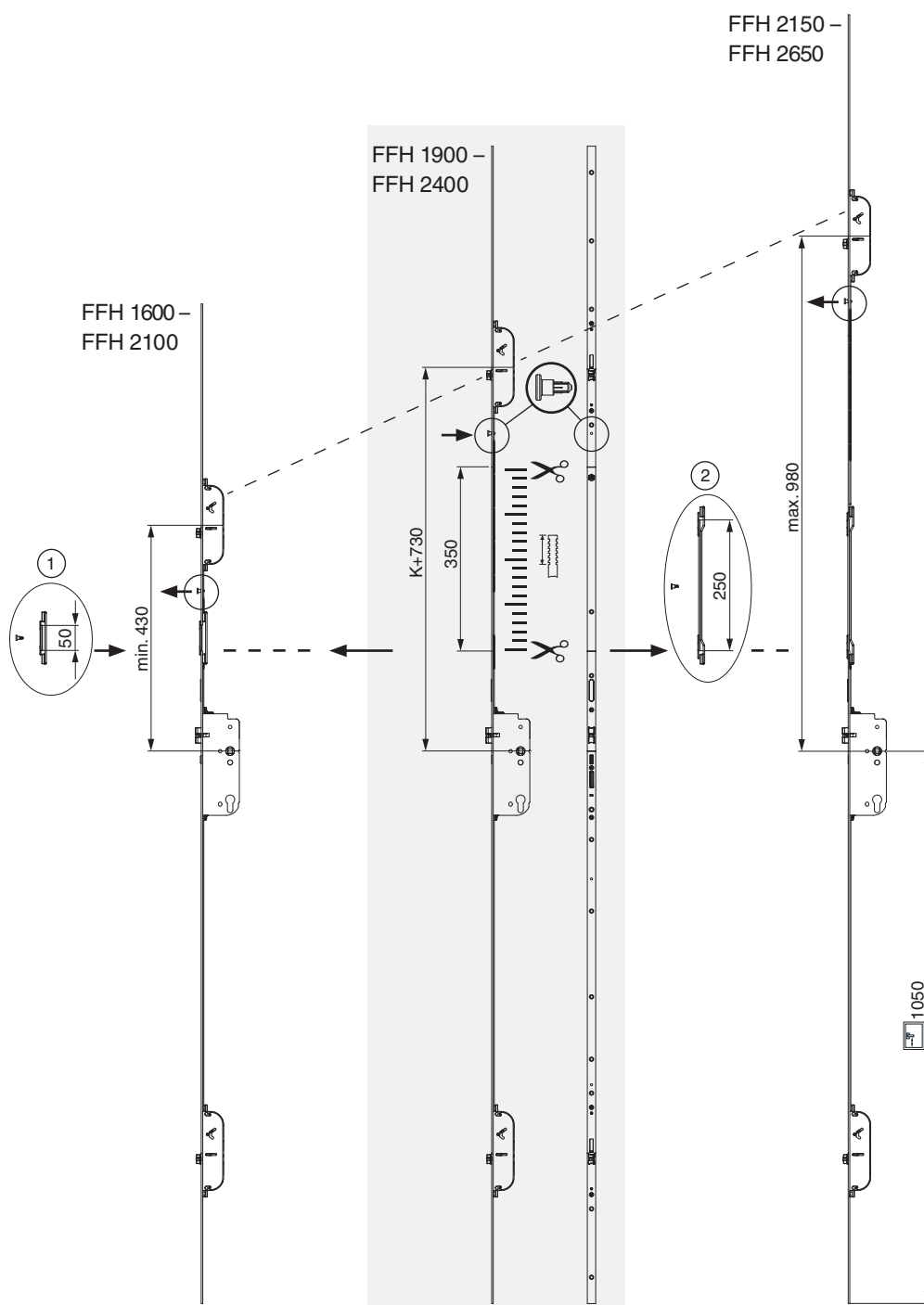



2 scrochi - ganci K+605

1 e 2 ante

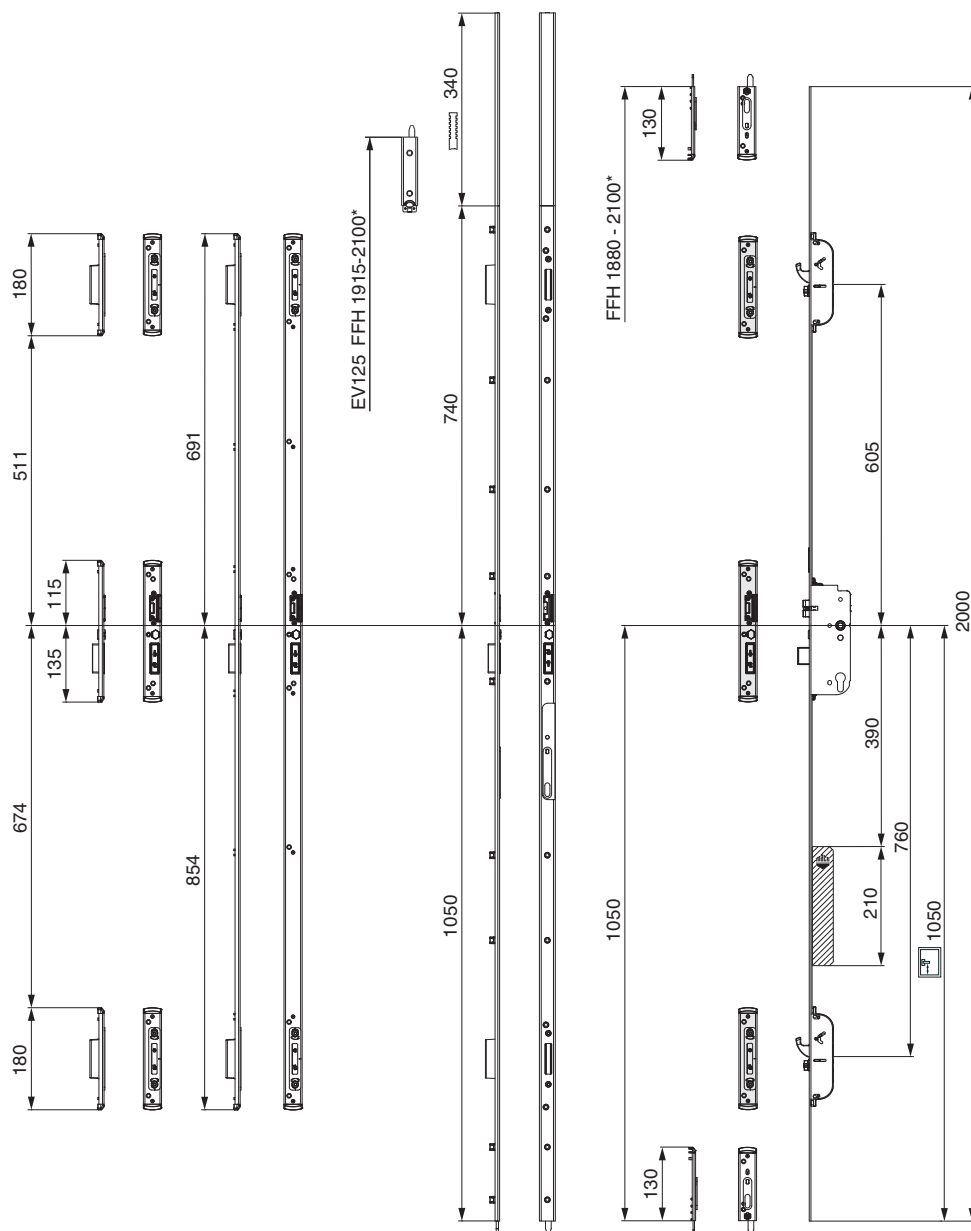

* Per HBB più alti usare frontali di copertura

☛ Motore per serratura autobloccante



2 scrochi - ganci K+730

1 e 2 ante

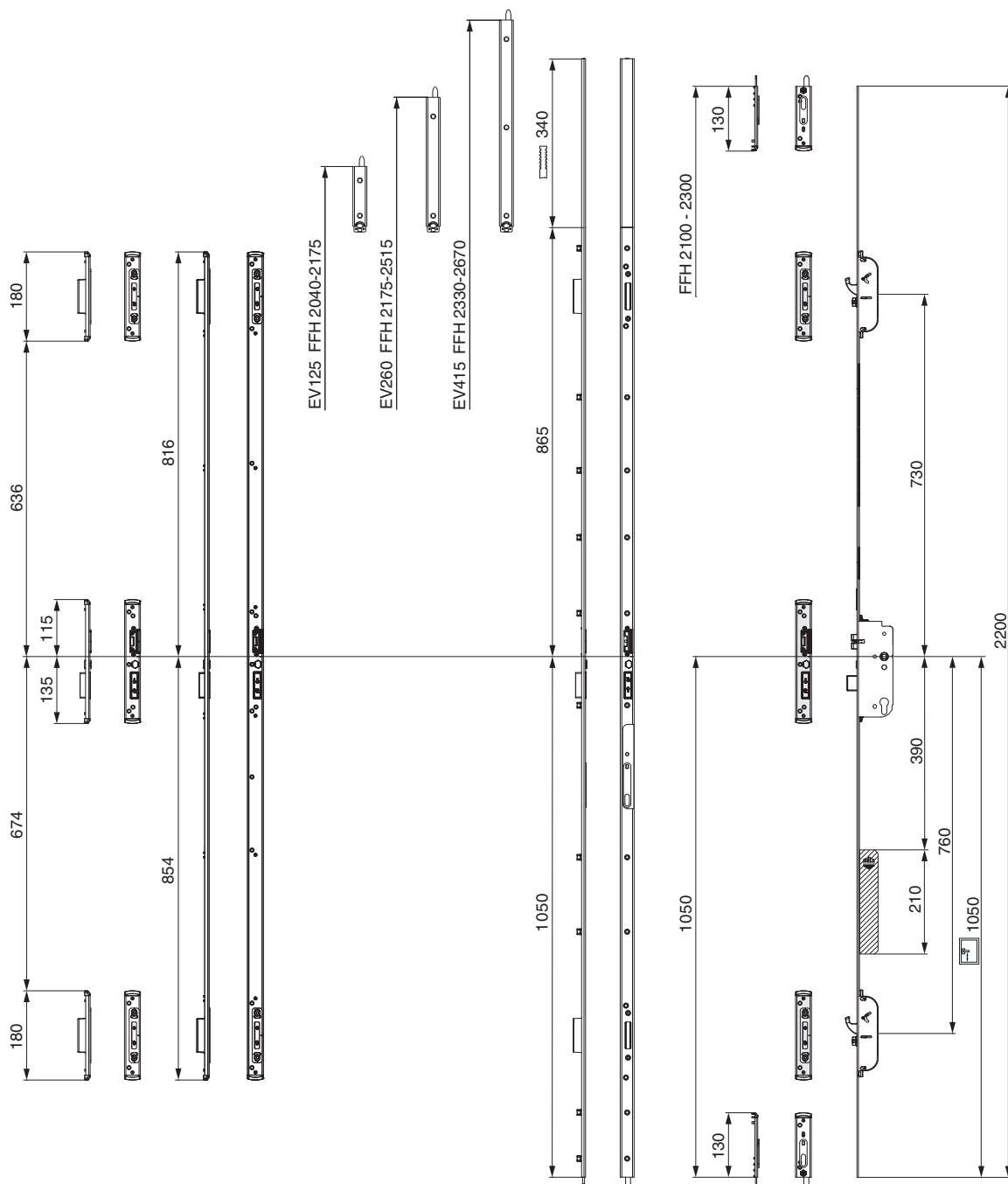

* Per HBB più alti usare frontali di copertura

☛ Motore per serratura autobloccante



2 scrochi - ganci K+980



1 e 2 ante

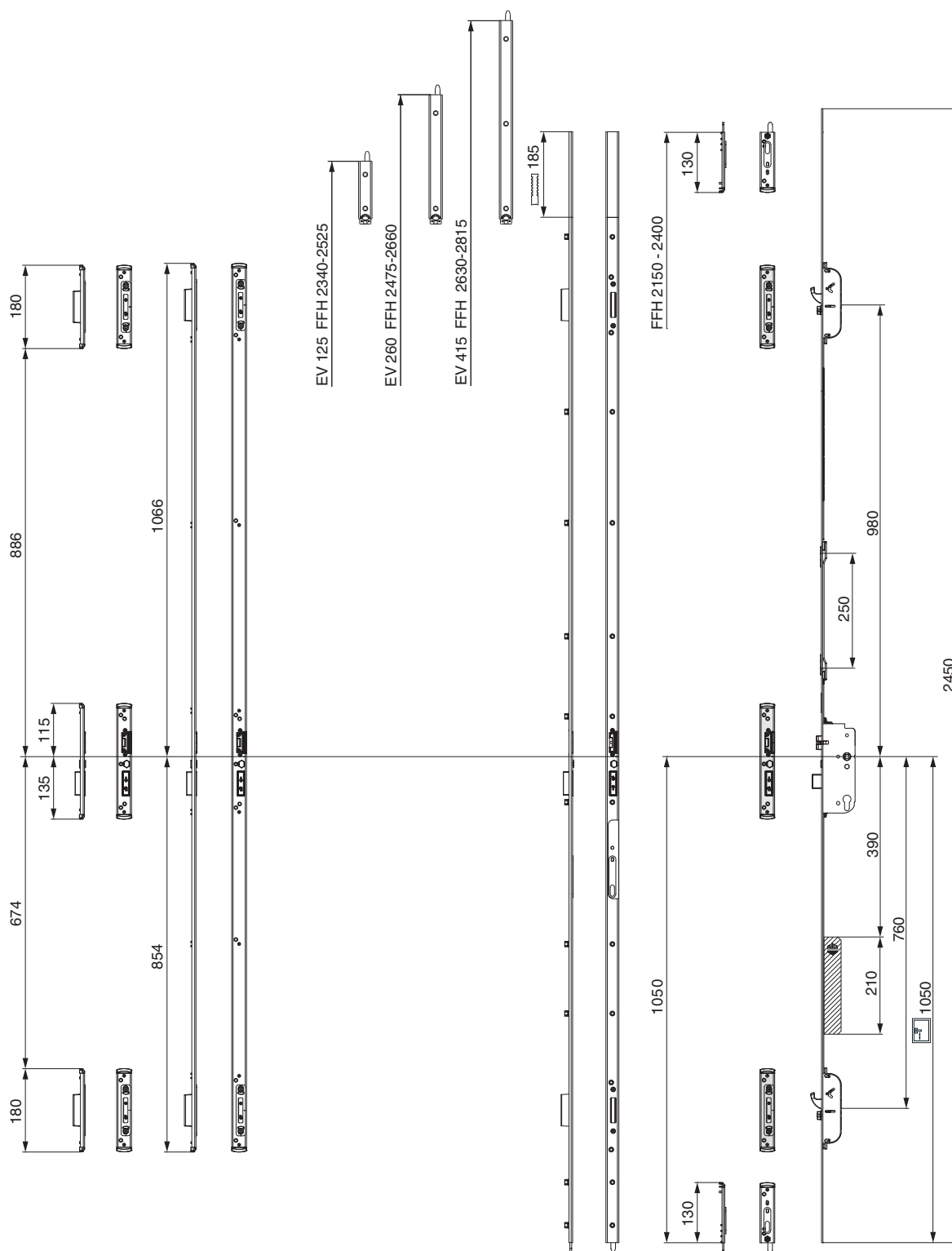





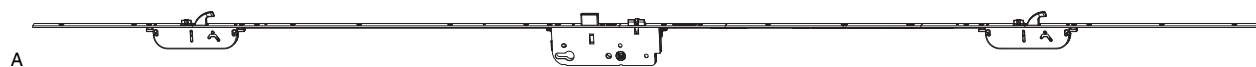

* Per HBB più alti usare frontali di copertura







● Motore per serratura autobloccante

2.2 Serratura autobloccante con 2 scrochi - 2 ganci







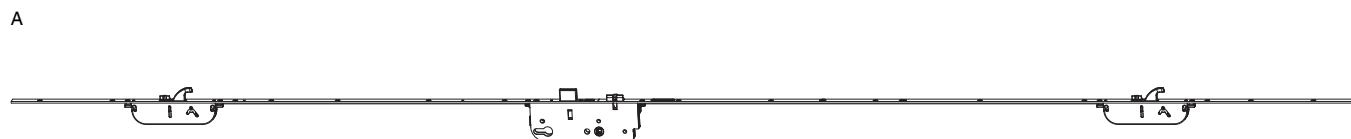

2.2.1 Serratura autobloccante I85 con 2 scrochi - ganci F16							L		N ^o	
fix	argento	85	35	8	1.050	2.000 - 2.400	16	2.200	5	245420*
			40	8	1.050	2.200 - 2.400	16	2.200	5	245421*
			45	8	1.050	2.000 - 2.400	16	2.200	5	245422*
			50	8	1.050	2.200 - 2.400	16	2.200	5	245423*
			55	8	1.050	2.200 - 2.400	16	2.200	5	A 245424*
			60	8	1.050	2.200 - 2.400	16	2.200	5	245425*
			65	8	1.050	2.200 - 2.400	16	2.200	5	245426*
			70	8	1.050	2.200 - 2.400	16	2.200	5	245427*
			80	8	1.050	2.200 - 2.400	16	2.200	5	245428*



2.2.2 Serratura autobloccante I85 con 2 scrochi - ganci F16 K+605							L		N ^o	
fix	argento	85	35	8	1.050	1.800 - 2.000	16	2.000	5	245480*
			40	8	1.050	1.800 - 2.000	16	2.000	5	245481*
			45	8	1.050	1.800 - 2.000	16	2.000	5	245482*
			50	8	1.050	1.800 - 2.000	16	2.000	5	245483*
			55	8	1.050	1.800 - 2.000	16	2.000	5	A 245484*
			60	8	1.050	1.800 - 2.000	16	2.000	5	245485*
			65	8	1.050	1.800 - 2.000	16	2.000	5	245486*
			70	8	1.050	1.800 - 2.000	16	2.000	5	245487*
			80	8	1.050	1.800 - 2.000	16	2.000	5	245488*



2.2.3 Serratura autobloccante I85 con 2 scrochi - ganci F16 K+980							L		N ^o	
fix	argento	85	35	8	1.050	2.200 - 2.400	16	2.400	5	245960
			40	8	1.050	2.200 - 2.400	16	2.400	5	245961*
			45	8	1.050	2.200 - 2.400	16	2.400	5	245962*
			50	8	1.050	2.200 - 2.400	16	2.400	5	245963*
			55	8	1.050	2.200 - 2.400	16	2.400	5	A 245964*
			60	8	1.050	2.200 - 2.400	16	2.400	5	245965*
			65	8	1.050	2.200 - 2.400	16	2.400	5	245966*
			70	8	1.050	2.200 - 2.400	16	2.400	5	245967*
			80	8	1.050	2.200 - 2.400	16	2.400	5	245968*



2.2.4 Serratura autobloccante I85 con 2 scrocci - ganci F20											No
fix	argento	85	45	8	1.050	2.200 - 2.400	20	2.200	5		245432*
			55	8	1.050	2.200 - 2.400	20	2.200	5	A	245434*
			60	8	1.050	2.200 - 2.400	20	2.200	5		245435*
			65	8	1.050	2.200 - 2.400	20	2.200	5		245436*
			70	8	1.050	2.200 - 2.400	20	2.200	5		245437*
			80	8	1.050	2.000 - 2.400	20	2.200	5		245438*

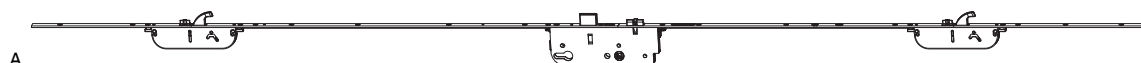

2.2.5 Serratura autobloccante I85 con 2 scrocci - ganci F20 K+605										No	
fix	argento	85	45	8	1.050	1.800 - 2.000	20	2.000	5		245492*
			55	8	1.050	1.800 - 2.000	20	2.000	5	A	245494*
			60	8	1.050	1.800 - 2.000	20	2.000	5		245495*
			65	8	1.050	1.800 - 2.000	20	2.000	5		245496*
			70	8	1.050	1.800 - 2.000	20	2.000	5		245497*
			80	8	1.050	1.800 - 2.000	20	2.000	5		245498*

A



2.2.6 Serratura autobloccante I85 con 2 scrocci - ganci F20 K+980										No	
fix	argento	85	45	8	1.050	2.200 - 2.400	20	2.400	5		245972*
			55	8	1.050	2.200 - 2.400	20	2.400	5	A	245974*
			60	8	1.050	2.200 - 2.400	20	2.400	5		245975*
			65	8	1.050	2.200 - 2.400	20	2.400	5		245976*
			70	8	1.050	2.200 - 2.400	20	2.400	5		245977*
			80	8	1.050	2.200 - 2.400	20	2.400	5		245978*





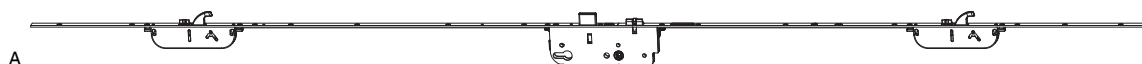

A



2.2.7 Serratura autobloccante I85 con 2 scrocci - ganci F24										No	
fix	argento	85	35	8	1.050	2.200 - 2.400	24	2.200	5		245440*
			40	8	1.050	2.200 - 2.400	24	2.200	5		245441*
			45	8	1.050	2.200 - 2.400	24	2.200	5		245442*
			55	8	1.050	2.000 - 2.400	24	2.200	5	A	245444*









A

2.2.8 Serratura autobloccante I85 con 2 scrochi - ganci F24 K+605								L		Nº
fix	argento	85	35	8	1.050	1.800 - 2.000	24	2.000	5	245920*
			40	8	1.050	1.800 - 2.000	24	2.000	5	245921*
			45	8	1.050	1.800 - 2.000	24	2.000	5	245922*
			55	8	1.050	1.800 - 2.000	24	2.000	5	245924*







A



2.2.9 Serratura autobloccante I85 con 2 scrochi - ganci F24 K+980							L		Nº	
fix	argento	85	35	8	1.050	2.200 - 2.400	24	2.400	5	245980*
			40	8	1.050	2.200 - 2.400	24	2.400	5	245981*
			45	8	1.050	2.200 - 2.400	24	2.400	5	245982*
			55	8	1.050	2.200 - 2.400	24	2.400	5	245984*







A



2.2.10 Serratura autobloccante I85 con 2 scrochi - ganci F24/16							L		Nº	
fix	argento	85	35	8	1.050	2.200 - 2.400	24/16	2.200	5	245450*
			40	8	1.050	2.200 - 2.400	24/16	2.200	5	245451*
			45	8	1.050	2.200 - 2.400	24/16	2.200	5	245452*
			50	8	1.050	2.200 - 2.400	24/16	2.200	5	245453*
			55	8	1.050	2.200 - 2.400	24/16	2.200	5	245454*
			60	8	1.050	2.200 - 2.400	24/16	2.200	5	245455*
			65	8	1.050	2.200 - 2.400	24/16	2.200	5	245456*
			70	8	1.050	2.200 - 2.400	24/16	2.200	5	245457*
			80	8	1.050	2.200 - 2.400	24/16	2.200	5	245458*

A



2.2.11 Serratura autobloccante I85 con 2 scrochi - ganci F24/16 K+605							L		Nº	
fix	argento	85	35	8	1.050	1.800 - 2.000	24/16	2.000	5	245930*
			40	8	1.050	1.800 - 2.000	24/16	2.000	5	245931*
			45	8	1.050	1.800 - 2.000	24/16	2.000	5	245932*
			50	8	1.050	1.800 - 2.000	24/16	2.000	5	245933*
			55	8	1.050	1.800 - 2.000	24/16	2.000	5	245934*
			60	8	1.050	1.800 - 2.000	24/16	2.000	5	245935*
			65	8	1.050	1.800 - 2.000	24/16	2.000	5	245936*
			70	8	1.050	1.800 - 2.000	24/16	2.000	5	245937*
			80	8	1.050	1.800 - 2.000	24/16	2.000	5	245938*

A



2.2.12 Serratura autobloccante I85 con 2 scroccchi - ganci F24/16 K+980													No
fix	argento	85	35	8	1.050	2.200 - 2.400	24/16	2.400	5				245990*
			40	8	1.050	2.200 - 2.400	24/16	2.400	5				245991*
			45	8	1.050	2.200 - 2.400	24/16	2.400	5				245992*
			50	8	1.050	2.200 - 2.400	24/16	2.400	5				245993*
			55	8	1.050	2.200 - 2.400	24/16	2.400	5	A			245994*
			60	8	1.050	2.200 - 2.400	24/16	2.400	5				245995*
			65	8	1.050	2.200 - 2.400	24/16	2.400	5				245996*
			70	8	1.050	2.200 - 2.400	24/16	2.400	5				245997*
			80	8	1.050	2.200 - 2.400	24/16	2.400	5				245998*



A

2.2.13 Serratura autobloccante I85 con 2 scroccchi - ganci U-6x24x6												No	
fix	argento	85	35	8	1.050	1.950 - 2.400	24	2.200	5				245460*
			40	8	1.050	1.950 - 2.400	24	2.200	5				245461*
			45	8	1.050	2.000 - 2.400	24	2.200	5				245462
			50	8	1.050	1.950 - 2.400	24	2.200	5				245463*
			55	8	1.050	1.950 - 2.400	24	2.200	5	A			245464*



A

2.2.14 Serratura autobloccante I85 con 2 scroccchi - ganci U-6x24x6 K+980												No	
fix	argento	85	35	8	1.050	2.200 - 2.400	24	2.200	5				230510*
			40	8	1.050	2.200 - 2.400	24	2.200	5				230511*
			45	8	1.050	2.200 - 2.400	24	2.200	5				230512*
			50	8	1.050	2.200 - 2.400	24	2.200	5				230513*
			55	8	1.050	2.200 - 2.400	24	2.200	5	A			230514*



A

2.2.15 Serratura autobloccante I85 con 2 scroccchi - ganci U-6x24x6 K+605												No	
fix	argento	85	35	8	1.050	1.800 - 2.200	24	2.000	5				245940*
			40	8	1.050	1.800 - 2.200	24	2.000	5				245941*
			45	8	1.050	1.800 - 2.200	24	2.000	5				245942*
			50	8	1.050	1.800 - 2.200	24	2.000	5				245943*
			55	8	1.050	1.800 - 2.200	24	2.000	5	A			245944*



3 Serratura automatica comando cilindro (Z-TF)

3.1	Serratura automatica comando cilindro con scrocci-punzoni	22
3.2	Serratura automatica comando cilindro scrocco-punzone	25
3.2.1	Serratura automatica comando cilindro con 2 scrocci -punzoni	25

3 Serratura automatica comando cilindro (Z-TF)

3.1 Serratura automatica comando cilindro con scrocci-punzoni



2 scrocci-punzoni
1 anta e 2 ante

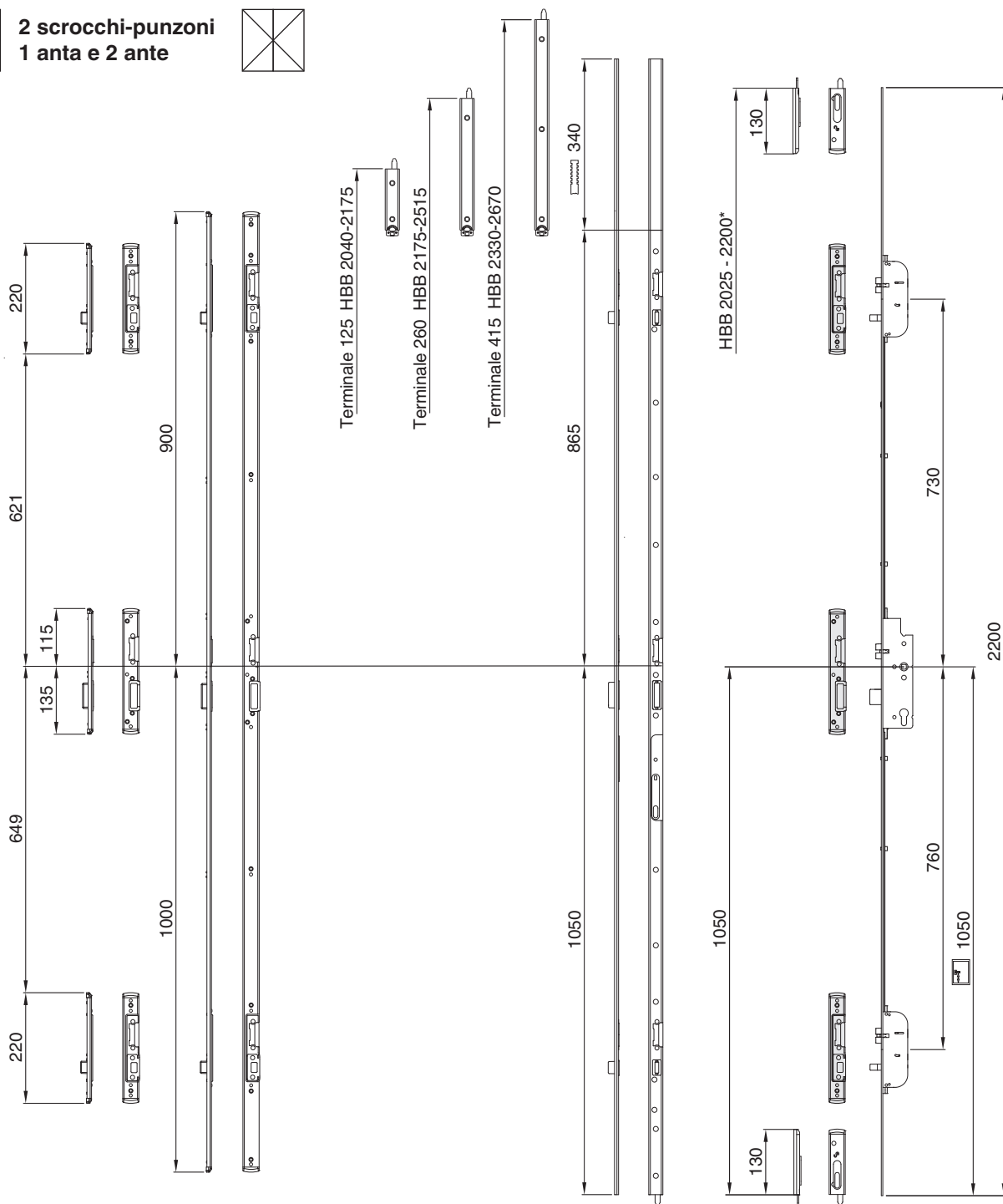

* HBB con catenaccio protoncino fino a 2300mm
opzionale con frontale di copertura

 **2 scrochi-punzoni K+605**
1 anta e 2 ante

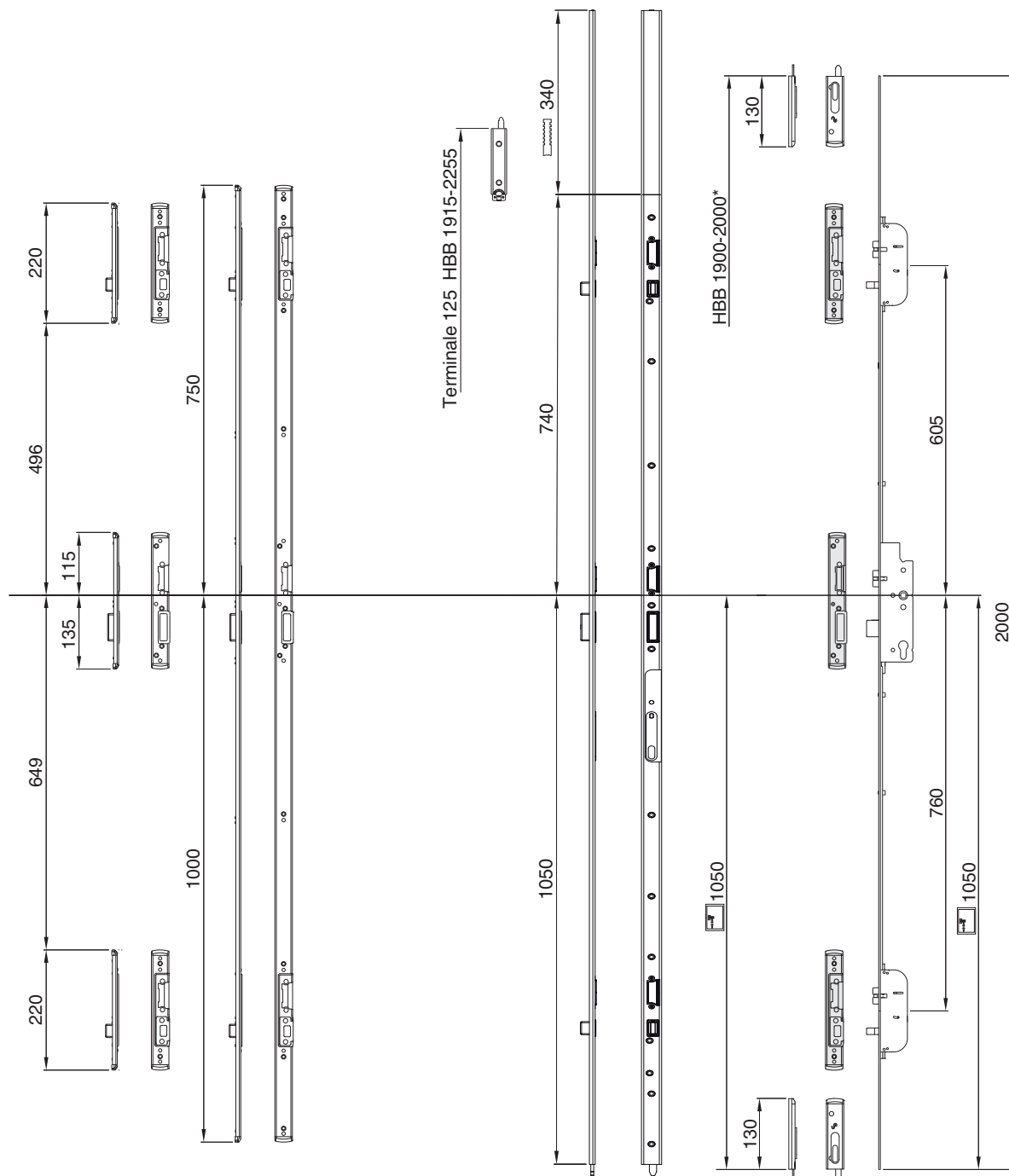
* HBB con catenaccio portoncino fino a 2100mm
opzionale con frontale di copertura



2 scrochi-punzoni K+980
1 anta e 2 ante

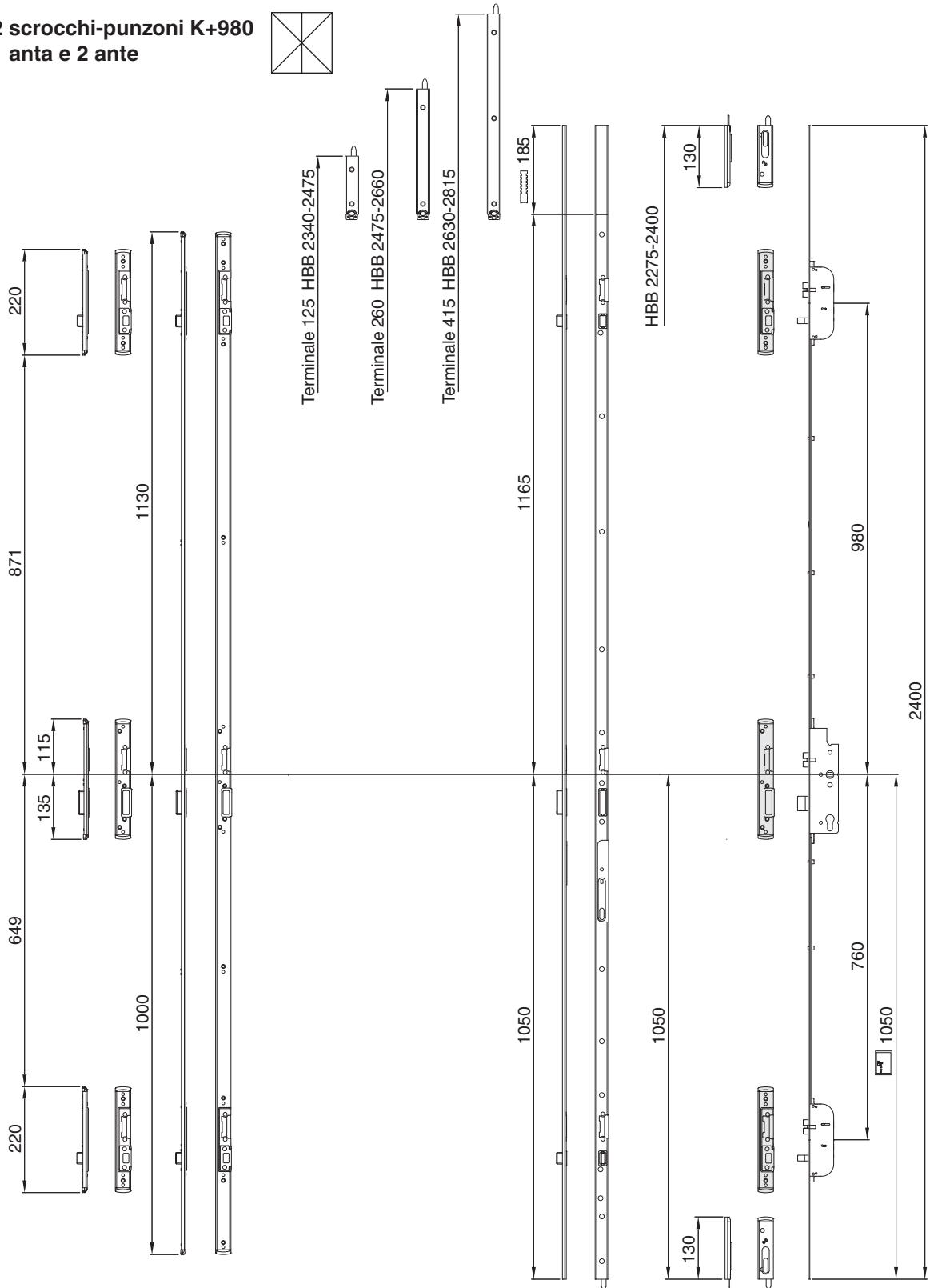

3.2 Serratura automatica comando cilindro scrocco-punzone

3.2.1 Serratura automatica comando cilindro con 2 scrochi -punzoni

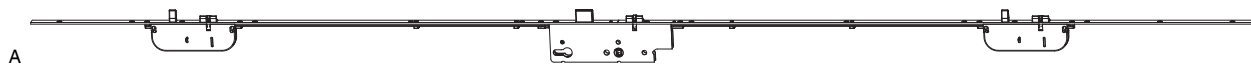

3.2.1.1 Serratura automatica l85 con 2 scrochi -punzoni F16



fix	argento	85	35	8	1.050	1.950 - 2.200	16	2.200	5	No
			40	8	1.050	1.950 - 2.200	16	2.200	5	239030
			45	8	1.050	1.950 - 2.200	16	2.200	5	239031
			50	8	1.050	1.950 - 2.200	16	2.200	5	239032
			55	8	1.050	1.950 - 2.200	16	2.200	5	239033
			55	8	1.050	1.950 - 2.200	16	2.200	5	239034
			65	8	1.050	1.950 - 2.200	16	2.200	5	239035
			70	8	1.050	1.950 - 2.200	16	2.200	5	239036*
			80	8	1.050	1.950 - 2.200	16	2.200	5	239037

A



3.2.1.2 Serratura automatica l85 con 2 scrochi -punzoni F16 K+980



fix	argento	85	35	8	1.050	2.200 - 2.400	16	2.400	5	No
			40	8	1.050	2.200 - 2.400	16	2.400	5	239130
			45	8	1.050	2.200 - 2.400	16	2.400	5	239131
			50	8	1.050	2.200 - 2.400	16	2.400	5	239132
			55	8	1.050	2.200 - 2.400	16	2.400	5	239133
			55	8	1.050	2.200 - 2.400	16	2.400	5	239134
			65	8	1.050	2.200 - 2.400	16	2.400	5	239135
			70	8	1.050	2.200 - 2.400	16	2.400	5	239136*
			80	8	1.050	2.200 - 2.400	16	2.400	5	239137*

A



3.2.1.3 Serratura automatica l85 con 2 scrochi -punzoni F16 K+605



fix	argento	85	35	8	1.050	1.800 - 2.000	16	2.000	5	No
			40	8	1.050	1.800 - 2.000	16	2.000	5	239080
			45	8	1.050	1.800 - 2.000	16	2.000	5	239081
			50	8	1.050	1.800 - 2.000	16	2.000	5	239082
			55	8	1.050	1.800 - 2.000	16	2.000	5	239083
			55	8	1.050	1.800 - 2.000	16	2.000	5	239084
			65	8	1.050	1.800 - 2.000	16	2.000	5	239085
			70	8	1.050	1.800 - 2.000	16	2.000	5	239086*
			80	8	1.050	1.800 - 2.000	16	2.000	5	239087*



A

3.2.1.4 Serratura automatica I85 con 2 scrocci -punzoni F20														No
fix	argento	85	35	8	1.050	2.000 - 2.200	20	2.200	5	A			239180*	
			40	8	1.050	2.000 - 2.200	20	2.200	5		239181			
			45	8	1.050	2.000 - 2.200	20	2.200	5		239182*			
			50	8	1.050	2.000 - 2.200	20	2.200	5		239183*			
			55	8	1.050	2.000 - 2.200	20	2.200	5		239184*			
			65	8	1.050	2.000 - 2.200	20	2.200	5		239185			
			70	8	1.050	2.000 - 2.200	20	2.200	5		239186*			
			80	8	1.050	2.000 - 2.200	20	2.200	5		239187*			

A



3.2.1.5 Serratura automatica I85 con 2 scrocci -punzoni F20 K+980														No
fix	argento	85	35	8	1.050	2.200 - 2.400	20	2.400	5	A			239280*	
			40	8	1.050	2.200 - 2.400	20	2.400	5		239281*			
			45	8	1.050	2.200 - 2.400	20	2.400	5		239282*			
			50	8	1.050	2.200 - 2.400	20	2.400	5		239283*			
			55	8	1.050	2.200 - 2.400	20	2.400	5		239284*			
			65	8	1.050	2.200 - 2.400	20	2.400	5		239285*			
			70	8	1.050	2.200 - 2.400	20	2.400	5		239286*			
			80	8	1.050	2.200 - 2.400	20	2.400	5		239287*			

A



3.2.1.6 Serratura automatica I85 con 2 scrocci -punzoni F20 K+605														No
fix	argento	85	35	8	1.050	1.800 - 2.000	20	2.000	5	A			239230*	
			40	8	1.050	1.800 - 2.000	20	2.000	5		239231*			
			45	8	1.050	1.800 - 2.000	20	2.000	5		239232*			
			50	8	1.050	1.800 - 2.000	20	2.000	5		239233*			
			55	8	1.050	1.800 - 2.000	20	2.000	5		239234*			
			65	8	1.050	1.800 - 2.000	20	2.000	5		239235*			
			70	8	1.050	1.800 - 2.000	20	2.000	5		239236*			
			80	8	1.050	1.800 - 2.000	20	2.000	5		239237*			

A



3.2.1.7 Serratura automatica I85 con 2 scrocci -punzoni F24														No
fix	argento	85	35	8	1.050	1.800 - 2.000	24	2.200	5	A			237360*	
			40	8	1.050	1.800 - 2.000	24	2.200	5		237361*			
			45	8	1.050	1.800 - 2.000	24	2.200	5		237362*			
			50	8	1.050	1.800 - 2.000	24	2.200	5		237363*			
			55	8	1.050	1.800 - 2.000	24	2.200	5		237364*			

A



3.2.1.8 Serratura automatica I85 con 2 scroccchi -punzoni F24 K+980							L		No	
fix	argento	85	35	8	1.050	2.200 - 2.400	24	2.400	5	239310*
			40	8	1.050	2.200 - 2.400	24	2.400	5	239311*
			45	8	1.050	2.200 - 2.400	24	2.400	5	239312*
			50	8	1.050	2.200 - 2.400	24	2.400	5	239313*
			55	8	1.050	2.200 - 2.400	24	2.400	5	239314*



A

3.2.1.9 Serratura automatica I85 con 2 scroccchi -punzoni F24 K+605							L		No	
fix	argento	85	35	8	1.050	1.800 - 2.000	24	2.000	5	237490*
			40	8	1.050	1.800 - 2.000	24	2.000	5	237491*
			45	8	1.050	1.800 - 2.000	24	2.000	5	237492*
			50	8	1.050	1.800 - 2.000	24	2.000	5	237493*
			55	8	1.050	1.800 - 2.000	24	2.000	5	237494*

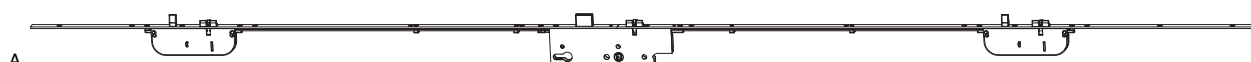

A

3.2.1.10 Serratura automatica I85 con 2 scroccchi -punzoni F24/16							L		No	
fix	argento	85	35	8	1.050	1.950 - 2.200	24/16	2.200	5	239360*
			40	8	1.050	1.950 - 2.200	24/16	2.200	5	239361*
			45	8	1.050	1.950 - 2.200	24/16	2.200	5	239362*
			50	8	1.050	1.950 - 2.200	24/16	2.200	5	239363
			55	8	1.050	1.950 - 2.200	24/16	2.200	5	239364*
			65	8	1.050	1.950 - 2.200	24/16	2.200	5	239365*
			80	8	1.050	1.950 - 2.200	24/16	2.200	5	239367*

A



3.2.1.11 Serratura automatica I85 con 2 scroccchi -punzoni F24/16 K+980							L		No	
fix	argento	85	35	8	1.050	2.200 - 2.400	24/16	2.400	5	239460*
			40	8	1.050	2.200 - 2.400	24/16	2.400	5	239461*
			45	8	1.050	2.200 - 2.400	24/16	2.400	5	239462*
			50	8	1.050	2.200 - 2.400	24/16	2.400	5	239463
			55	8	1.050	2.200 - 2.400	24/16	2.400	5	239464*
			65	8	1.050	2.200 - 2.400	24/16	2.400	5	239465*
			70	8	1.050	2.200 - 2.400	24/16	2.400	5	239466*
			80	8	1.050	2.200 - 2.400	24/16	2.400	5	239467*



3.2.1.12 Serratura automatica I85 con 2 scrocci -punzoni F24/16 K+605								L		No
fix	argento	85	35	8	1.050	1.800 - 2.000	24/16	2.000	5	239410*
			40	8	1.050	1.800 - 2.000	24/16	2.000	5	239411*
			45	8	1.050	1.800 - 2.000	24/16	2.000	5	239412*
			50	8	1.050	1.800 - 2.000	24/16	2.000	5	239413*
			55	8	1.050	1.800 - 2.000	24/16	2.000	5	239414*
			65	8	1.050	1.800 - 2.000	24/16	2.000	5	239415*
			70	8	1.050	1.800 - 2.000	24/16	2.000	5	239416*
			80	8	1.050	1.800 - 2.000	24/16	2.000	5	239417*

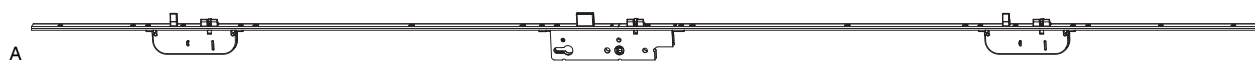

3.2.1.13 Serratura automatica I85 con 2 scrocci -punzoni U-6x24x6								L		No
fix	argento	85	35	8	1.050	1.950 - 2.200	24	2.200	5	237210*
			40	8	1.050	1.950 - 2.200	24	2.200	5	237211*
			45	8	1.050	1.950 - 2.200	24	2.200	5	237212
			50	8	1.050	1.950 - 2.200	24	2.200	5	237213*
			55	8	1.050	1.950 - 2.200	24	2.200	5	237214*

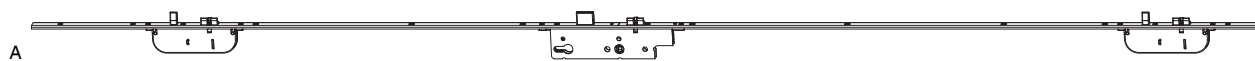

3.2.1.14 Serratura automatica I85 con 2 scrocci -punzoni U-6x24x6 K+980								L		No
fix	argento	85	35	8	1.050	2.200 - 2.400	24	2.200	5	237310*
			40	8	1.050	2.200 - 2.400	24	2.200	5	237311*
			45	8	1.050	2.200 - 2.400	24	2.200	5	237312
			50	8	1.050	2.200 - 2.400	24	2.200	5	237313*
			55	8	1.050	2.200 - 2.400	24	2.200	5	237314*



4 Serratura comando cilindro modulare (Z-TS)

4.1	Composizione ferramenta serratura comando cilindro _____	30
4.2	Serratura comando cilindro modulare con funghi _____	35
4.3	Serratura comando cilindro modulare con ganci-punzoni e funghi _____	36
4.4	Serratura comando cilindro modulare con ganci-punzoni _____	37
4.5	Serratura comando cilindro modulare con punzoni e funghi _____	39
4.6	Serratura comando cilindro modulare con punzoni _____	40

4 Serratura comando cilindro modulare (Z-TS)

4.1 Composizione ferramenta serratura comando cilindro

3.1m

La costruzione 'modulare' di PROTECT MODUL

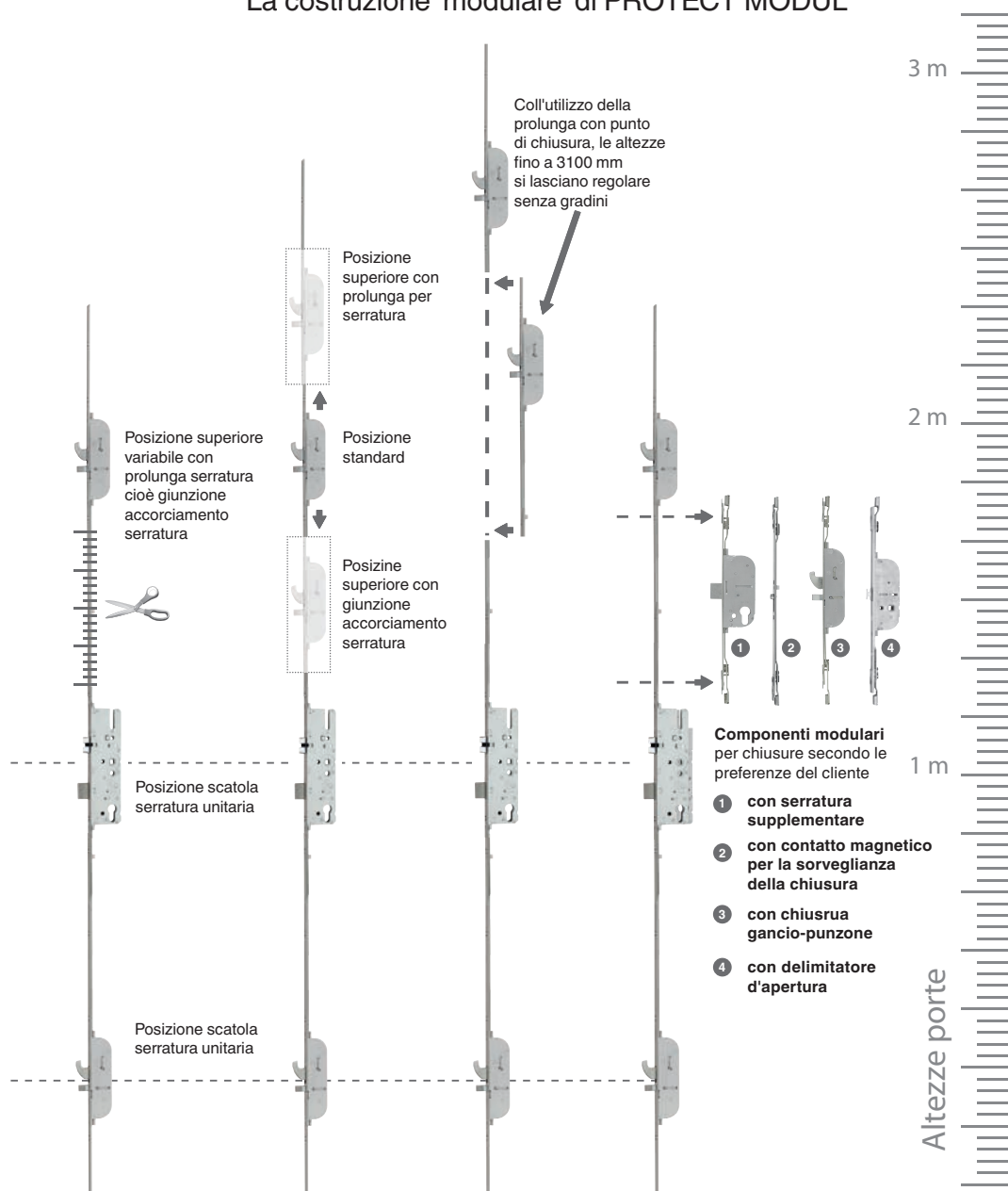

Posizione scatola serratura unitaria

- ① Combinazione con 2 ganci e 2 punzoni
- ② Combinazione con 4 ganci e 4 punzoni

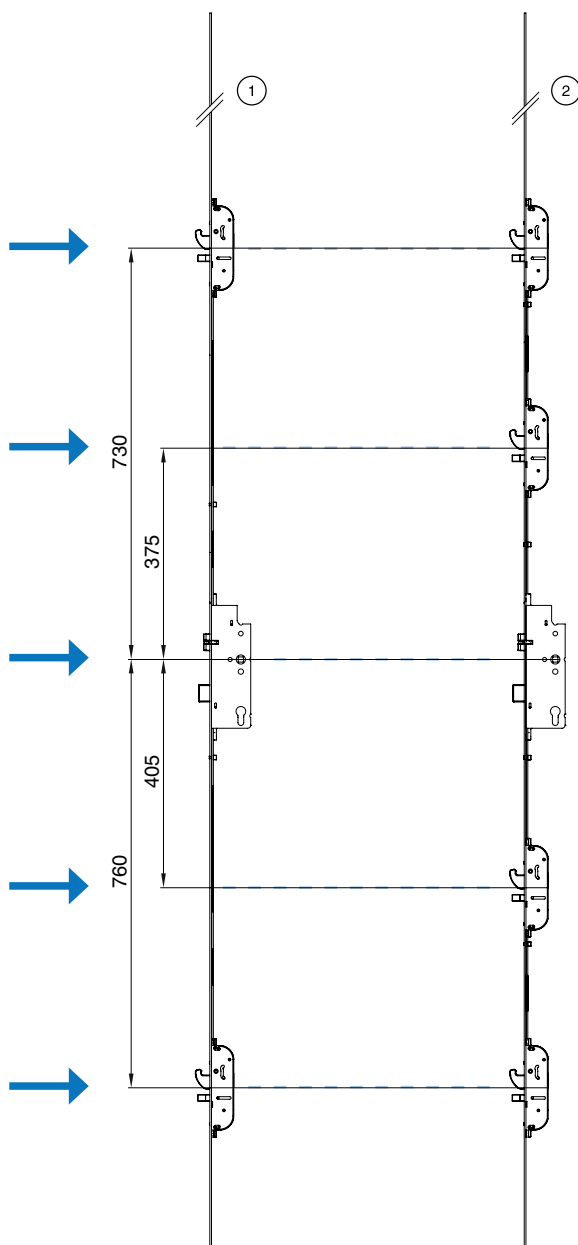

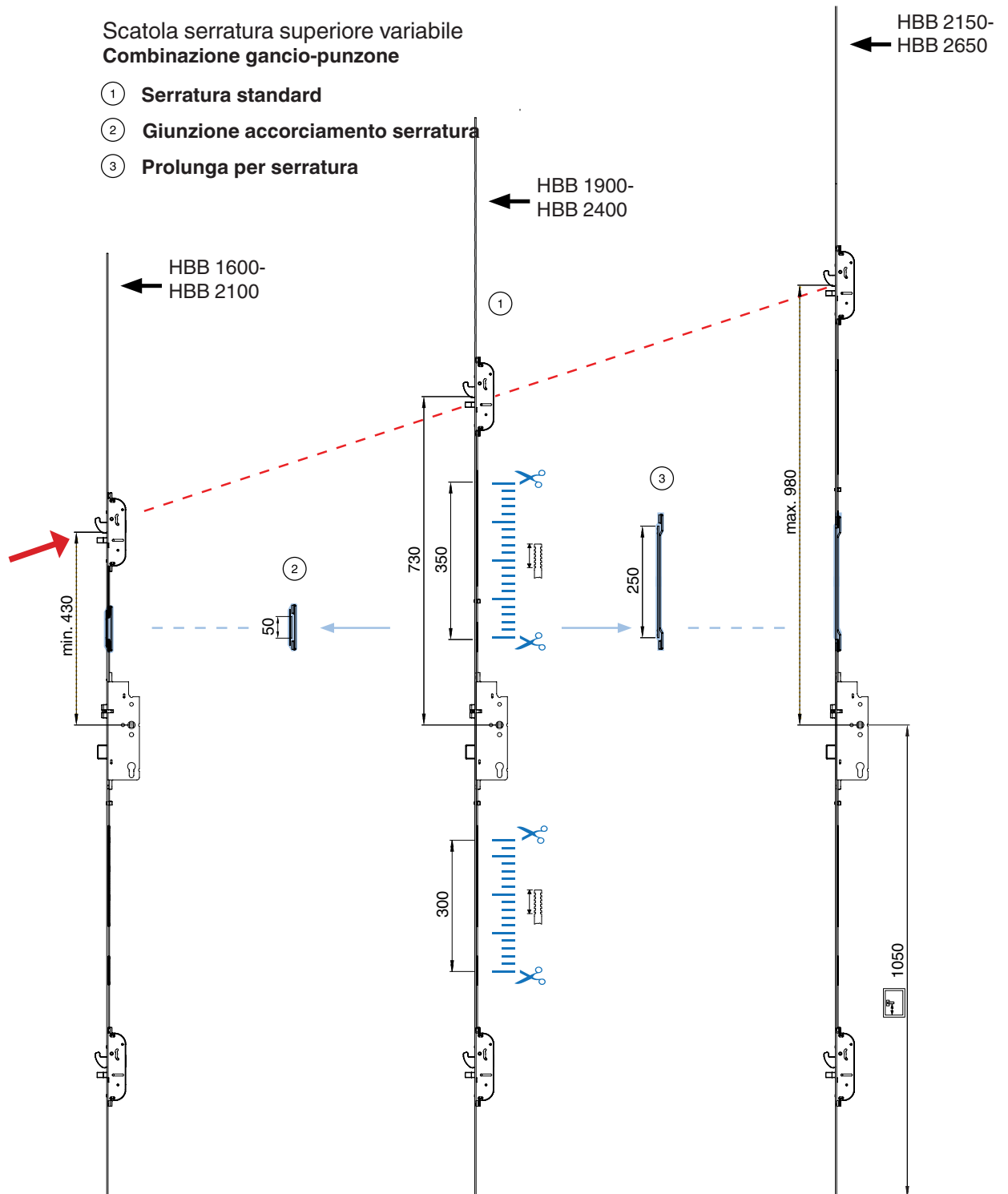

Componenti frontali variabili

- ① Serratura standard
- ② Componente frontale con serratura supplementare
- ③ Componente frontale con gancio-punzone
- ④ Componente frontale con contatto magnetico
- ⑤ Componente frontale con delimitatore d'apertura

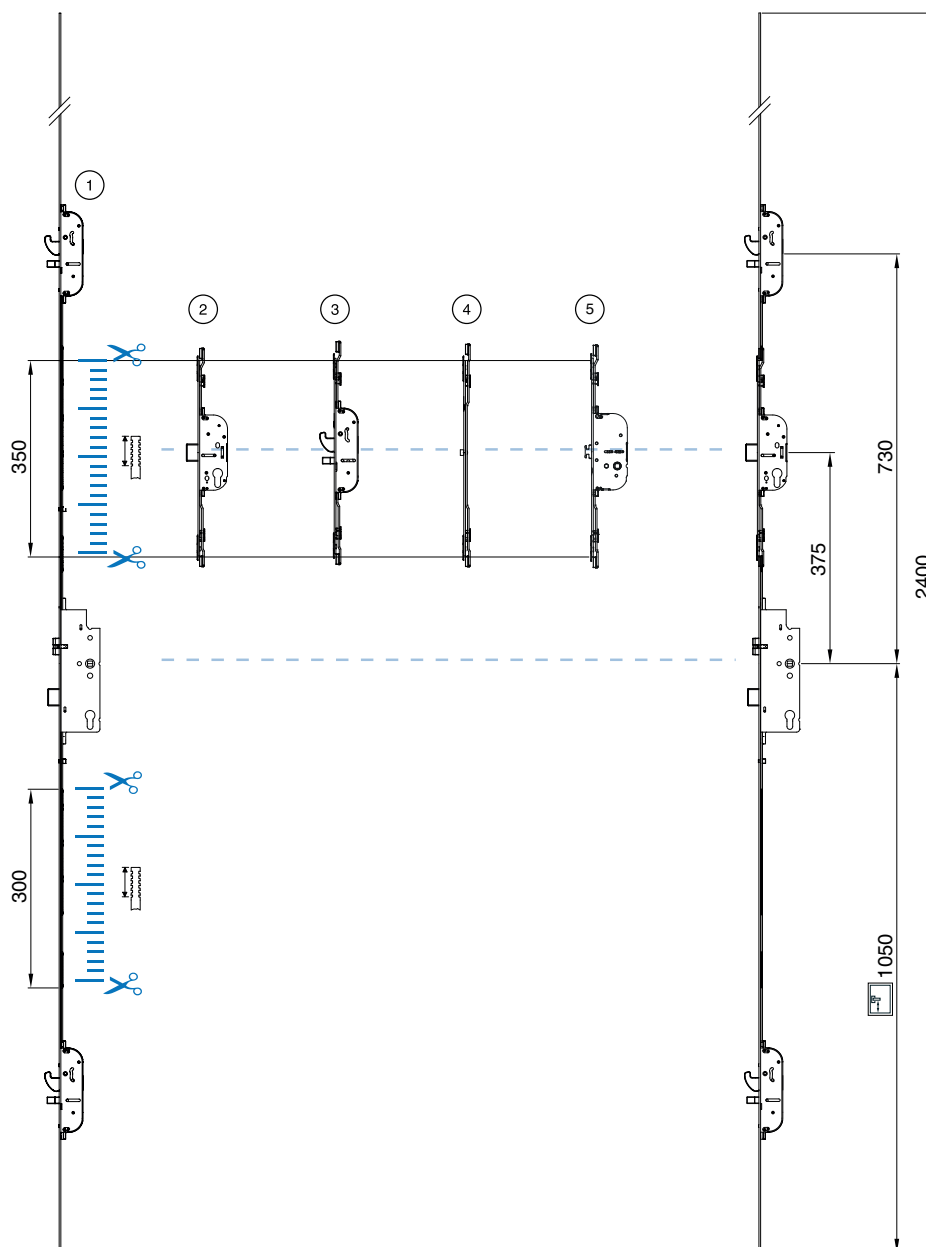

2 ganci-punzoni, 2 ganci, 2 punzoni

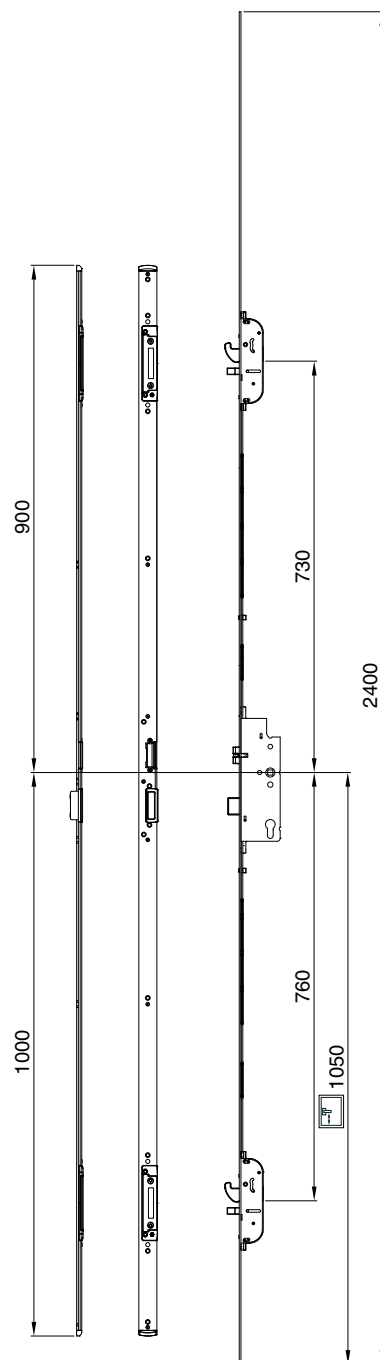
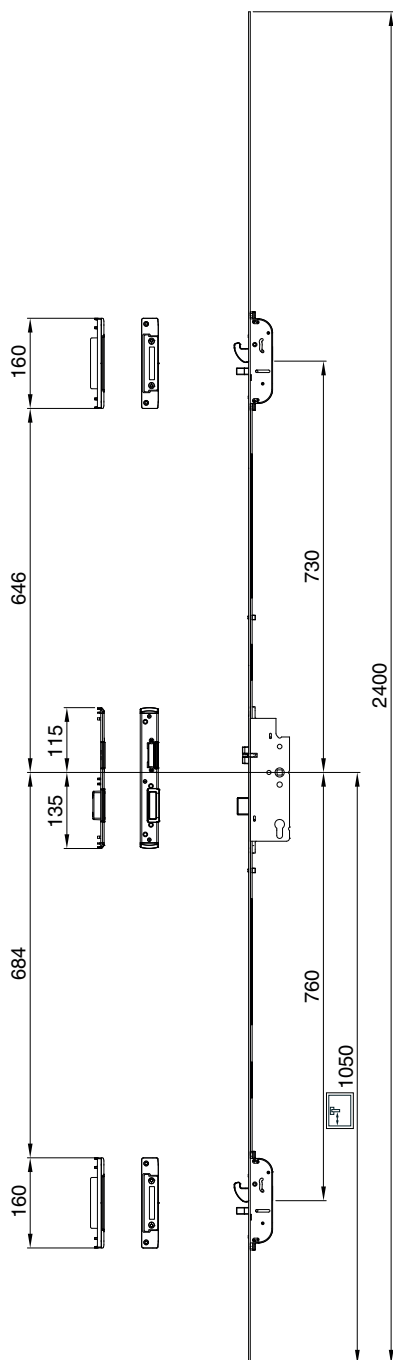

4.2 Serratura comando cilindro modulare con funghi

4.2.1 Serratura comando cilindro modulare con 3 funghi



4.2.1.1 Serratura comando cilindro modulare con 3 funghi F16



prolungabile	argento	85	35	8	1.050	1.600 - 1.800	16	1.800	5		No
			40	8	1.050	1.600 - 1.800	16	1.800	5		230211
			45	8	1.050	1.600 - 1.800	16	1.800	5		230212
			50	8	1.050	1.600 - 1.800	16	1.800	5		230213
			55	8	1.050	1.600 - 1.800	16	1.800	5	A	230214
			65	8	1.050	1.600 - 1.800	16	1.800	5		230215
			70	8	1.050	1.600 - 1.800	16	1.800	5		230216*
			80	8	1.050	1.600 - 1.800	16	1.800	5		230217*

4.2.2 Serratura comando cilindro modulare con 4 funghi

A



4.2.2.1 Serratura comando cilindro modulare I85 con 4 funghi F16



prolungabile senza mandata	argento	85	25	8	1.050	1.950 - 2.400	16	2.400	5		No
			30	8	1.050	1.950 - 2.400	16	2.400	5		234171
prolungabile	argento	85	35	8	1.050	1.950 - 2.400	16	2.400	5		230000
			40	8	1.050	1.950 - 2.400	16	2.400	5		230001
			45	8	1.050	1.950 - 2.400	16	2.400	5		230002
			50	8	1.050	1.950 - 2.400	16	2.400	5		230003
			55	8	1.050	1.950 - 2.400	16	2.400	5	A	230004
			65	8	1.050	1.950 - 2.400	16	2.400	5		230005
			70	8	1.050	1.950 - 2.400	16	2.400	5		230006
			80	8	1.050	1.950 - 2.400	16	2.400	5		230007

A



4.2.2.2 Serratura comando cilindro modulare I85 con 4 funghi F20



prolungabile	argento	85	35	8	1.050	1.950 - 2.400	20	2.400	5		No
			40	8	1.050	1.950 - 2.400	20	2.400	5		230241*
			45	8	1.050	1.950 - 2.400	20	2.400	5		230242
			50	8	1.050	1.950 - 2.400	20	2.400	5		230243*
			55	8	1.050	1.950 - 2.400	20	2.400	5	A	230244*
			65	8	1.050	1.950 - 2.400	20	2.400	5		230245
			70	8	1.050	1.950 - 2.400	20	2.400	5		230246*
			80	8	1.050	1.950 - 2.400	20	2.400	5		230247

4.3 Serratura comando cilindro modulare con ganci-punzoni e funghi

4.3.1 Serratura comando cilindro modulare con 2 ganci-punzoni e 1 fungo



A

4.3.1.1 Serratura comando cilindro modulare I85 con 2 ganci-punzoni e 1 fungo F16								L		No
prolungabile	argento	85	35	8	1.050	1.950 - 2.400	16	1.800	5	239950*
			40	8	1.050	1.950 - 2.400	16	1.800	5	239951
			45	8	1.050	1.950 - 2.400	16	1.800	5	239952
			50	8	1.050	1.950 - 2.400	16	1.800	5	239953
			55	8	1.050	1.950 - 2.400	16	1.800	5	A 239954
			65	8	1.050	1.950 - 2.400	16	1.800	5	239955
			70	8	1.050	1.950 - 2.400	16	1.800	5	239956*
			80	8	1.050	1.950 - 2.400	16	1.800	5	239957*

4.3.2 Serratura comando cilindro modulare con 2 ganci-punzoni e 2 funghi

A



4.3.2.1 Serratura comando cilindro modulare I85 con 2 ganci-punzoni e 2 funghi F16								L		No
prolungabile	argento	85	35	8	1.050	1.950 - 2.400	16	2.400	5	238550
			40	8	1.050	1.950 - 2.400	16	2.400	5	238551
			45	8	1.050	1.950 - 2.400	16	2.400	5	238552
			50	8	1.050	1.950 - 2.400	16	2.400	5	238553
			55	8	1.050	1.950 - 2.400	16	2.400	5	A 238554
			65	8	1.050	1.950 - 2.400	16	2.400	5	238555
			70	8	1.050	1.950 - 2.400	16	2.400	5	238556*
			80	8	1.050	1.950 - 2.400	16	2.400	5	238557*

4.4 Serratura comando cilindro modulare con ganci-punzoni

4.4.1 Serratura comando cilindro modulare con 2 ganci-punzoni

A



4.4.1.1 Serratura comando cilindro modulare I85 con 2 ganci-punzoni F16								L		No
modulare	argento	85	35	8	1.050	1.950 - 2.400	16	2.400	5	235790*
			40	8	1.050	1.950 - 2.400	16	2.400	5	235791
			45	8	1.050	1.950 - 2.400	16	2.400	5	235792*
			50	8	1.050	1.950 - 2.400	16	2.400	5	235793
			55	8	1.050	1.950 - 2.400	16	2.400	5	A 235794
			65	8	1.050	1.950 - 2.400	16	2.400	5	235795
			70	8	1.050	1.950 - 2.400	16	2.400	5	235796*
			80	8	1.050	1.950 - 2.400	16	2.400	5	235797

A



4.4.1.2 Serratura comando cilindro modulare I85 con 2 ganci-punzoni F20								L		No
modulare	argento	85	35	8	1.050	1.950 - 2.400	20	2.400	5	235830*
			40	8	1.050	1.950 - 2.400	20	2.400	5	235831*
			45	8	1.050	1.950 - 2.400	20	2.400	5	235832*
			50	8	1.050	1.950 - 2.400	20	2.400	5	235833
			55	8	1.050	1.950 - 2.400	20	2.400	5	A 235834
			65	8	1.050	1.950 - 2.400	20	2.400	5	235835
			70	8	1.050	1.950 - 2.400	20	2.400	5	235836
			80	8	1.050	1.950 - 2.400	20	2.400	5	235837

A



4.4.1.3 Serratura comando cilindro modulare I85 con 2 ganci-punzoni F24								L		No
modulare	argento	85	35	8	1.050	1.950 - 2.400	24	2.400	5	235870*
			40	8	1.050	1.950 - 2.400	24	2.400	5	235871*
			45	8	1.050	1.950 - 2.400	24	2.400	5	235872*
			50	8	1.050	1.950 - 2.400	24	2.400	5	235873*
			55	8	1.050	1.950 - 2.400	24	2.400	5	A 235874
			65	8	1.050	1.950 - 2.400	24	2.400	5	235875*

A



4.4.1.4 Serratura comando cilindro modulare I85 con 2 ganci-punzoni F24/16								L		No
modulare	argento	85	35	8	1.050	1.950 - 2.400	24/16	2.400	5	237610*
		40	8	1.050	1.950 - 2.400	24/16	2.400	5	237611*	
		45	8	1.050	1.950 - 2.400	24/16	2.400	5	237612*	
		50	8	1.050	1.950 - 2.400	24/16	2.400	5	237613*	
		55	8	1.050	1.950 - 2.400	24/16	2.400	5	A 237614*	
		65	8	1.050	1.950 - 2.400	24/16	2.400	5	237615*	
		70	8	1.050	1.950 - 2.400	24/16	2.400	5	237616*	
		80	8	1.050	1.950 - 2.400	24/16	2.400	5	237617*	



A

4.4.1.5 Serratura comando cilindro modulare I85 con 2 ganci-punzoni U-6x24x6								L		No
modulare	argento	85	35	8	1.050	1.950 - 2.200	24	2.200	5	236570*
		40	8	1.050	1.950 - 2.200	24	2.200	5	236571*	
		45	8	1.050	1.950 - 2.200	24	2.200	5	236572	
		50	8	1.050	1.950 - 2.200	24	2.200	5	236573*	
		55	8	1.050	1.950 - 2.200	24	2.200	5	A 236574*	

4.4.2 Serratura comando cilindro modulare con 4 ganci-punzoni

A



4.4.2.1 Serratura comando cilindro modulare I85 con 4 ganci-punzoni F20								L		No
modulare	argento	85	35	8	1.050	1.950 - 2.400	20	2.400	5	235090*
		45	8	1.050	1.950 - 2.400	20	2.400	5	235092*	
		50	8	1.050	1.950 - 2.400	20	2.400	5	235093	
		55	8	1.050	1.950 - 2.400	20	2.400	5	A 235094*	
		65	8	1.050	1.950 - 2.400	20	2.400	5	235095*	
		70	8	1.050	1.950 - 2.400	20	2.400	5	235096	
		80	8	1.050	1.950 - 2.400	20	2.400	5	235097	

4.5 Serratura comando cilindro modulare con punzoni e funghi

4.5.1 Serratura comando cilindro modulare con 2 punzoni e 1 fungo



4.5.1.1 Serratura comando cilindro modulare I85 con 2 punzoni e 1 fungo F16								L		No
prolungabile	argento	85	35	8	1.050	1.600 - 1.800	16	1.800	5	239960
			40	8	1.050	1.600 - 1.800	16	1.800	5	239961
			45	8	1.050	1.600 - 1.800	16	1.800	5	239962
			50	8	1.050	1.600 - 1.800	16	1.800	5	239963
			55	8	1.050	1.600 - 1.800	16	1.800	5	239964
			65	8	1.050	1.600 - 1.800	16	1.800	5	239965
			70	8	1.050	1.600 - 1.800	16	1.800	5	239966*

4.5.2 Serratura comando cilindro modulare con 2 punzoni e 2 funghi

A



4.5.2.1 Serratura comando cilindro modulare I85 con 2 punzoni e 2 funghi F16								L		No
prolungabile	argento	85	35	8	1.050	1.950 - 2.400	16	2.400	5	238600
			40	8	1.050	1.950 - 2.400	16	2.400	5	238601
			45	8	1.050	1.950 - 2.400	16	2.400	5	238602
			50	8	1.050	1.950 - 2.400	16	2.400	5	238603
			55	8	1.050	1.950 - 2.400	16	2.400	5	238604
			65	8	1.050	1.950 - 2.400	16	2.400	5	238605
			70	8	1.050	1.950 - 2.400	16	2.400	5	238606*
			80	8	1.050	1.950 - 2.400	16	2.400	5	238607*

A



4.5.2.2 Serratura comando cilindro modulare I85 con 2 punzoni e 2 funghi F20								L		No
prolungabile	argento	85	35	8	1.050	1.950 - 2.400	20	2.400	5	238750*
			40	8	1.050	1.950 - 2.400	20	2.400	5	238751*
			45	8	1.050	1.950 - 2.400	20	2.400	5	238752*
			50	8	1.050	1.950 - 2.400	20	2.400	5	238753*
			55	8	1.050	1.950 - 2.400	20	2.400	5	238754*
			65	8	1.050	1.950 - 2.400	20	2.400	5	238755*
			70	8	1.050	1.950 - 2.400	20	2.400	5	238756*
			80	8	1.050	1.950 - 2.400	20	2.400	5	238757*

4.6 Serratura comando cilindro modulare con punzoni

4.6.1 Serratura comando cilindro modulare con 2 punzoni

A



4.6.1.1 Serratura comando cilindro modulare I85 con 2 punzoni F16								L		No
modulare	argento	85	35	8	1.050	1.950 - 2.400	16	2.400	5	234420
		40	8	1.050	1.950 - 2.400	16	2.400	5	234421	
		45	8	1.050	1.950 - 2.400	16	2.400	5	234422	
		50	8	1.050	1.950 - 2.400	16	2.400	5	234423	
		55	8	1.050	1.950 - 2.400	16	2.400	5	A 234424	
		65	8	1.050	1.950 - 2.400	16	2.400	5	234425	
		70	8	1.050	1.950 - 2.400	16	2.400	5	234426	
		80	8	1.050	1.950 - 2.400	16	2.400	5	234427	

A



4.6.1.2 Serratura comando cilindro modulare I85 con 2 punzoni F20								L		No
modulare	argento	85	35	8	1.050	1.950 - 2.400	20	2.400	5	234480*
		40	8	1.050	1.950 - 2.400	20	2.400	5	234481*	
		45	8	1.050	1.950 - 2.400	20	2.400	5	234482	
		50	8	1.050	1.950 - 2.400	20	2.400	5	234483	
		55	8	1.050	1.950 - 2.400	20	2.400	5	A 234484	
		65	8	1.050	1.950 - 2.400	20	2.400	5	234485	
		70	8	1.050	1.950 - 2.400	20	2.400	5	234486	
		80	8	1.050	1.950 - 2.400	20	2.400	5	234487	



5 Serratura comando maniglia prolungabile (G-TS)

5.1	Composizione ferramenta serratura comando maniglia	42
5.2	Serratura comando maniglia prolungabile con funghi	43
5.2.1	Serratura comando maniglia prolungabile con 4 funghi	43

5 Serratura comando maniglia prolungabile (G-TS)

5.1 Composizione ferramenta serratura comando maniglia

4 funghi

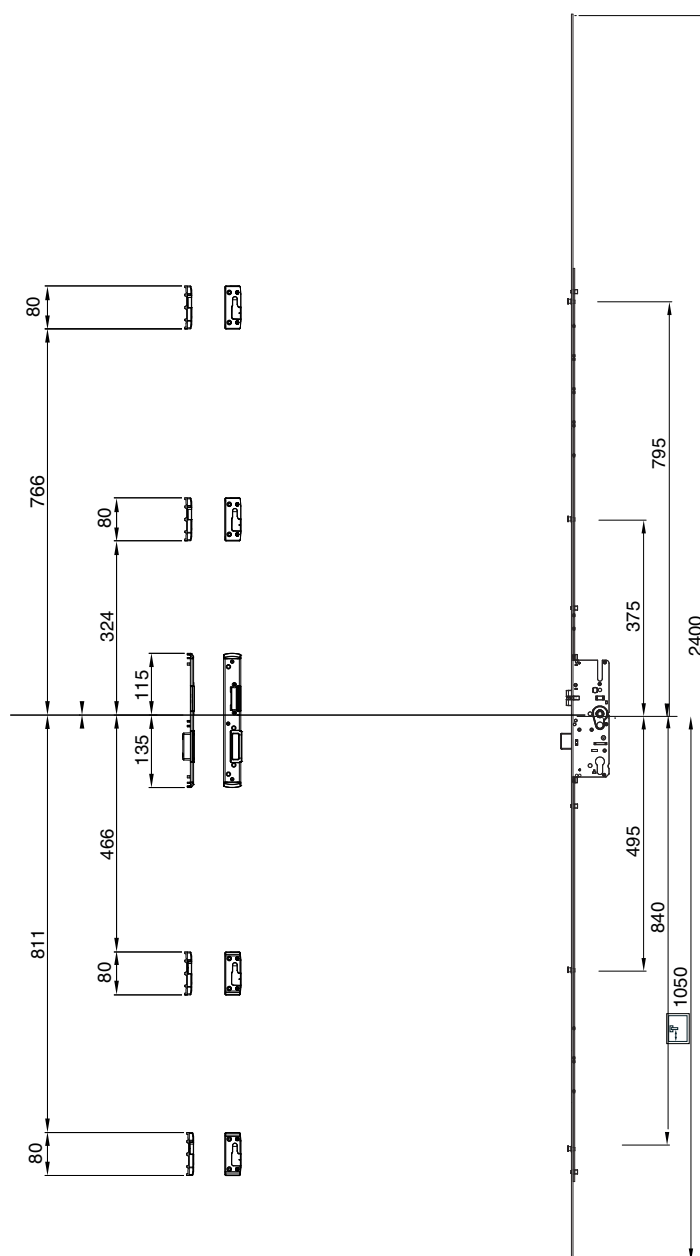







5.2 Serratura comando maniglia prolungabile con funghi

5.2.1 Serratura comando maniglia prolungabile con 4 funghi

A



5.2.1.1 Serratura comando maniglia I85 con 4 funghi F16								L		No
prolungabile	argento	85	28	8	1.050	1.950 - 2.400	16	2.400	5	58461
			35	8	1.050	1.950 - 2.400	16	2.400	5	58462
			40	8	1.050	1.950 - 2.400	16	2.400	5	58455
			45	8	1.050	1.950 - 2.400	16	2.400	5	58453
			50	8	1.050	1.950 - 2.400	16	2.400	5	58456
			55	8	1.050	1.950 - 2.400	16	2.400	5	58452
			65	8	1.050	1.950 - 2.400	16	2.400	5	58457*

MACO
PROTECT



Serratura comando maniglia prolungabile (G-TS)

MACO
PROTECT



6 Serratura per portafinestra (B-TV)

6.1	Composizione serratura per portafinestra	46
6.2	Serrature per portafinestra Multi Matic I85	47
6.3	Accessori per serratura portafinestra Multi Matic	48
6.3.1	Prolunga frontale per serratura portafinestra Multi Matic	48
6.3.2	Movimento angolare per serratura portafinestra	48
6.3.3	Terminale superiore con fungo	48
6.3.4	Terminale superiore con fungo e puntale	48
6.3.5	Terminale inferiore senza nottolino con puntale	48

6 Serratura per portafinestra (B-TV)

6.1 Composizione serratura per portafinestra

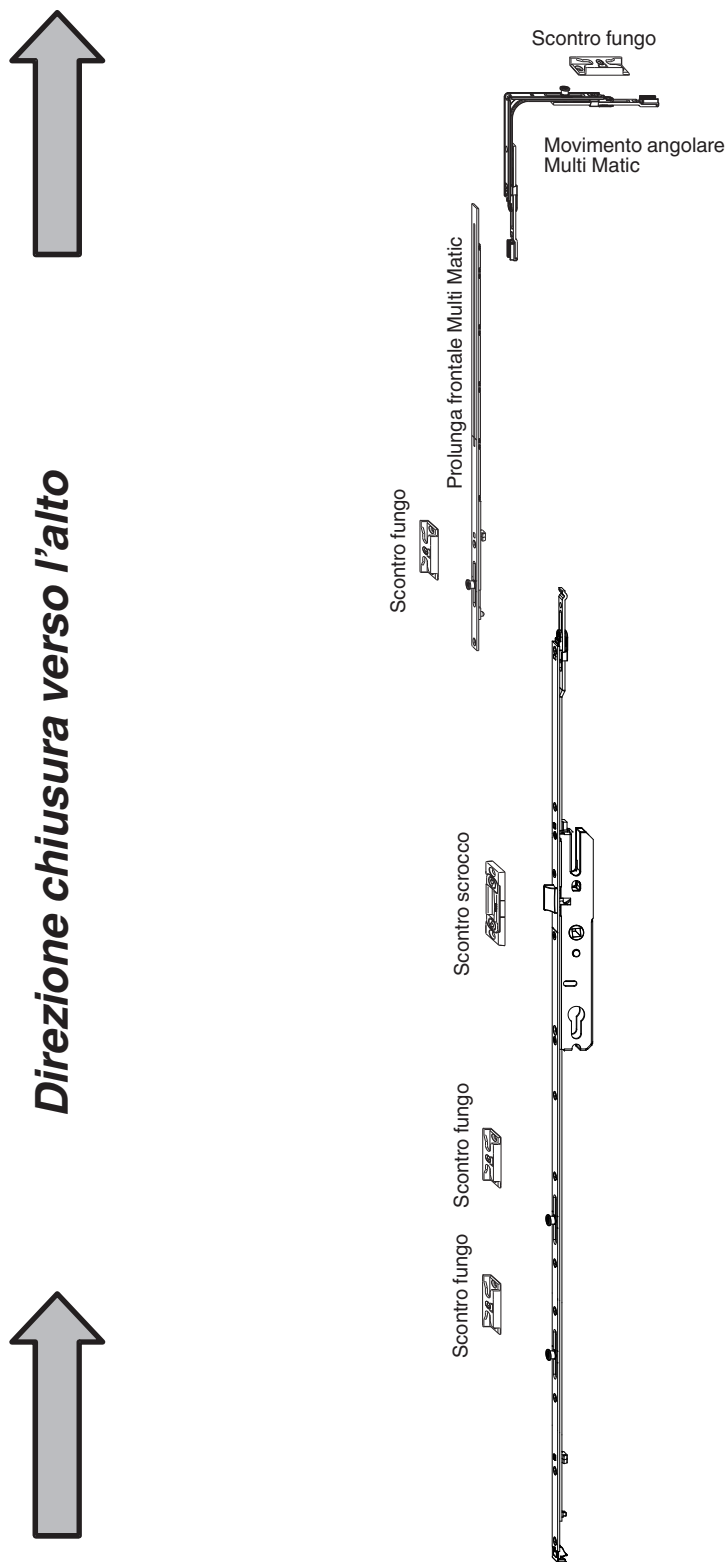







Direzione chiusura verso l'alto

 *Combinazione possibile con ferramenta per finestre MULTI-MATIC*



A

6.2 Serrature per portafinestra Multi Matic I85							L		Nº	
argento	MM fix	28	8	1.050	2	85	1.347	5	A	203834
		35	8	1.050	2	85	1.347	5		203835
		40	8	1.050	2	85	1.347	5		203836
		45	8	1.050	2	85	1.347	5		203837
		50	8	1.050	2	85	1.347	5		203838
		55	8	1.050	2	85	1.347	5		203839

6.3 Accessori per serratura portafinestra Multi Matic



6.3.1 Prolunga frontale per serratura portafinestra Multi Matic

argento



L



Nº

1	1.701 - 1.950	497	10	A	203697
	1.951 - 2.200	747	10		203698
2	2.201 - 2.450	997	10		203699



6.3.2 Movimento angolare per serratura portafinestra

argento

con 1 fungo



Nº

	320 - 1.800	360 - 2.800	50	A	222201
--	-------------	-------------	----	---	---------------



6.3.3 Terminale superiore con fungo

argento



L



Nº

1	113,5	20	A	212687
---	-------	----	---	---------------



6.3.4 Terminale superiore con fungo e puntale

argento



L



Nº

	431 - 2.450	80	100	A	214013
			100	B	214014
			100	C	218977
			100	D	218978*
		113,5	20	E	208432
			20	F	214016



6.3.5 Terminale inferiore senza nottolino con puntale

argento



L



Nº

	500 - 2.350	16	170	170	20	A	225092
--	-------------	----	-----	-----	----	---	---------------

7 Scontri

7.1	Scontri legno	50
7.1.1	Scontri A4 scostamento 9mm	50
7.1.2	Scontri A4 scostamento 10mm	53
7.1.3	Scontri A4 scostamento 13mm	55
7.1.4	Scontri A12 scostamento 9 mm	57
7.1.5	Scontri A12 scostamento 10 mm	60
7.1.6	Scontri A12 scostamento 13 mm	61
7.2	Scontri cava ferramenta contrapposta	64
7.2.1	Scontri per scrocco-mandata	64
7.2.2	Scontri per nottolino	64
7.2.3	Scontri per fungo	64
7.2.4	Scontri per gancio-punzone	64
7.2.5	Scontri per scrocco-punzone	65
7.2.6	Scontri per scrocco	65
7.2.7	Scontri per scrocco portafinestra	65
7.2.8	Scontri per delimitatore d'apertura	65
7.3	Asta scontri legno	66
7.3.1	Asta Scontri legno U-6x24x6 scostamento 13mm	66
7.4	Scontri PVC	67
7.4.1	Scontri e aste scontri per serratura autobloccante	67
7.4.2	Scontri e aste scontri per serratura comando maniglia/comando cilindro modulare	68
7.4.3	Scontri per serratura automatica	69
7.4.4	Aste scontri per serratura automatica	70
7.5	Scontri Alu	71
7.5.1	Scontri Alu 3 mm battuta liscia scost. 13	71
7.5.2	Scontri Alu 3 mm scost.10 canalino 14mm	72
7.5.3	Scontri Alu U-6/24/6 scost. 13	73
7.5.4	Scontri Alu scost.9 canalino 14 mm	74
7.5.5	Scontri Alu scost.13 canalino 14 mm	75

7 Scontri

7.1 Scontri legno

7.1.1 Scontri A4 scostamento 9mm



7.1.1.1 Scontri per scrocco-mandata			L	B	H		N ^o
argento	destro	Scontro scrocco-mandata per serratura autobloccante A4 scost.9 mm	220	18	8	20	219231
	sinistro	Scontro scrocco-mandata per serratura autobloccante A4 scost.9 mm	220	18	8	20	A 219232
		Scontro scrocco-mandata per aria 4mm	208	18	8	50	B 29776^{1,2}

¹ Utilizzabile con coprifresata 43524

² Utilizzabile con terminale 43718 per legno A12

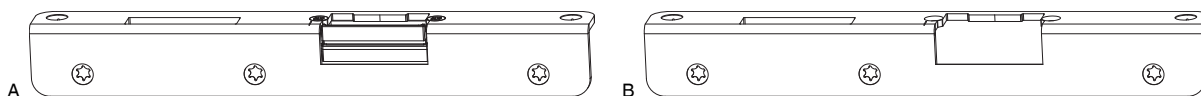

7.1.1.2 Scontri ad angolo scrocco mandata			L	a	b		N ^o
argento	destro	Scontro scrocco-mandata ad angolo con inserto per aria 4mm	250	32 x 25	20		203502*
		Scontro scrocco-mandata ad angolo per apriporta elettrico per legno	250	32 x 25	20		354952
		Scontro scrocco-mandata ad angolo per apriporta elettrico per aria 4mm pressione - 1 mm	250	15 x 25	20		360112*
	sinistro	Scontro scrocco-mandata ad angolo con inserto per aria 4mm	250	32 x 25	20	A	203503*
		Scontro scrocco-mandata ad angolo per apriporta elettrico per legno	250	32 x 25	20	B	354954
		Scontro scrocco-mandata ad angolo per apriporta elettrico per aria 4mm pressione - 1 mm	250	15 x 25	20		360113*



7.1.1.3 Scontri per scrocco-mandata (scrocco a rullo)			L	B	H		N ^o
argento	destro	Scontro scrocco-mandata per scrocco a rullo per aria 4mm	208	18	8	50	59421^{1,2}
	sinistro	Scontro scrocco-mandata per scrocco a rullo per aria 4mm	208	18	8	10	A 59420^{1,2}

¹ Utilizzabile con coprifresata 43524

² Utilizzabile con terminale 43718 per legno A12



7.1.1.4 Scontri per nottolino A4			L	B	H		N ^o
argento	per A4 scost. 9 mm		90	18	8	200	A 30545



7.1.1.5 Scontri per fungo A4			L	B	H		N ^o
argento	destro	per A4 scost. 9 mm pressione - 1 mm	90	18	8	100	96305 ^{1,2}
		per A4 scost. 9 mm con vite inclinata	90	18	8	100	96565 ¹
	sinistro	per A4 scost. 9 mm pressione - 1 mm	90	18	8	100	96306 ^{1,2}
		per A4 scost. 9 mm con vite inclinata	90	18	8	100	A 96566 ¹

¹ Per porte destre usare scontri sinistri e viceversa!

² Senza conformità con la norma EN 1627



7.1.1.6 Scontri per gancio-punzone			L	B	H		N ^o
argento	Scontro gancio-punzone per aria 4mm		180	18	8	20	A 207862 ^{1,2}

¹ Utilizzabile con coprifresata 358024

² Utilizzabile con terminale 43718 per legno A12



7.1.1.7 Scontri per scrocco-punzone			L	B	H		N ^o
argento	destro	Scontro scrocco-punzone A4 scost.9 mm	180	18	8	20	218939
	sinistro	Scontro scrocco-punzone A4 scost.9 mm	180	18	8	20	A 218940

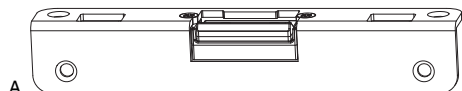

7.1.1.8 Scontri ad angolo per scrocco-punzone			L			N ^o
argento	Scontro scrocco - punzone ad angolo con inserto scrocco A4 scost.10 mm		190	32 x 25	20	A 214968*



7.1.1.9 Scontri per scrocco			L	B	H		N ^o
argento	Scontro scrocco per serratura automatica A4 scost.9 mm		120	18	8	20	A 210501 ¹

¹ Utilizzabile con terminale 360074 per A12

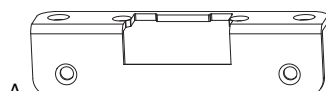

7.1.1.10 Scontri ad angolo per scrocco			L			N ^o
argento	Scontro scrocco per scrocco elettrico per A4 scost. 9 mm		130	32 x 25	20	A 362002*



7.1.1.11 Scontri per scrocco portafinestra

		L	B	H		No
argento	per aria 4mm regolabile	90	18	8	50	A 94118¹

¹ Utilizzabile con terminale 43718 per legno A12

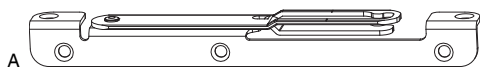

7.1.1.12 Scontri per delimitatore d'apertura

		L			No
argento	destro Scontro per delimitatore d'apertura A4 scost.9 mm	200	20 x 18	20	212936*
	sinistro Scontro per delimitatore d'apertura A4 scost.9 mm	200	20 x 18	20	A 212937*



7.1.1.13 Scontri catenaccio puntale 10x5

		L	B	H		No
argento	Scontro punzone per aria 4mm	120	18	8	20	A 26799¹
	Scontro catenaccio 2 fori per A4 scost. 9 mm	120	18	8	20	B 50576

¹ Utilizzabile con coprifresata 41250



7.1.1.14 Scontri catenaccio puntale 8x4

		L	B	H		No
argento	per A4 scost. 9 mm 2 fori	90	18	8	100	A 23883¹
	per A4 scost. 9 mm 1 foro	90	18	8	100	B 55112¹

¹ Utilizzabile con terminale 43718 per legno A12

7.1.2 Scontri A4 scostamento 10mm



7.1.2.1 Scontri per scrocco-mandata			L	B	H		N ^o
argento	destro	Scontro scrocco-mandata per serratura autobloccante A4 scost. 10 mm	220	20	8	20	219235
	sinistro	Scontro scrocco-mandata per serratura autobloccante A4 scost. 10 mm	220	20	8	20	A 219236
		Scontro scrocco-mandata per aria 4mm	208	20	8	50	B 29787 ^{1,2}

¹ Utilizzabile con terminale 354358 per aria 12 mm

² Utilizzabile con coprifresata 43524



7.1.2.2 Scontri per nottolino A4			L	B	H		N ^o
argento	per A4 scost. 9 mm con vite inclinata		90	20	8	50	A 34004 ¹

¹ Utilizzabile con terminale 354358 per aria 12 mm



7.1.2.3 Scontri per fungo A4			L	B	H		N ^o
argento	destro	per aria 4mm con vite inclinata	90	20	8	100	96845 ^{1*}
	sinistro	per aria 4mm con vite inclinata	90	20	8	100	A 96846 ^{1*}

¹ Per porte destre usare scontri sinistri e viceversa!



7.1.2.4 Scontri per gancio-punzone			L	B	H		N ^o
argento	dx+sx	Scontro gancio-punzone per aria 4mm	180	20	8	20	A 207861 ^{1,2}

¹ Utilizzabile con coprifresata 358024

² Utilizzabile con terminale 354358 per aria 12 mm

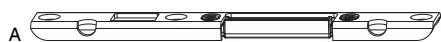

7.1.2.5 Scontri per scrocco-punzone			L	B	H		N ^o
argento	destro	Scontro scrocco-punzone A4 scost. 10 mm	180	20	8	20	218943*
	sinistro	Scontro scrocco-punzone A4 scost. 10 mm	180	20	8	20	A 218944*

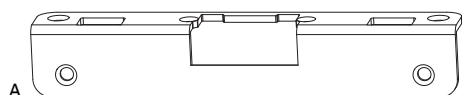

7.1.2.6 Scontri ad angolo per scrocco-punzone			L			N ^o
Scontri ad angolo scrocco-punzone senza inserto scrocco A4 scost. 10 mm argento			190	a b 32 x 25	20	A 363322*



7.1.2.7 Scontri per scrocco		L	B	H		No
argento	Scontro scrocco per aria 4mm	120	20	8	20	A 210502 ¹

¹ Utilizzabile con terminale 354358 per aria 12 mm

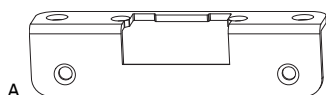

7.1.2.8 Scontri ad angolo per scrocco		L			No
Scontro scrocco per scrocco elettrico per A4 scostamento 9 argento		130	32 x 25	20	A 362002*

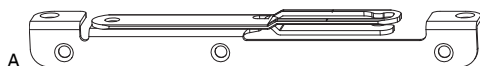

7.1.2.9 Scontri per delimitatore d'apertura		L			No	
Scontro per delimitatore d'apertura sinistro A4 scost. 10 mm argento		sinistro	200	20 x 20	20	A 212939

7.1.3 Scontri A4 scostamento 13mm

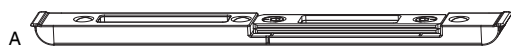

7.1.3.1 Scontri per scrocco-mandata			L	B	H		Nº
argento	destro	Scontro scrocco-mandata per A4 scost. 13 mm	208	22	8	50	209907
	sinistro	Scontro scrocco-mandata per A4 scost. 13 mm	208	22	8	50	A 209908



7.1.3.2 Scontri ad angolo-scrocco mandata			L	a	b		Nº
Scontri ad angolo scrocco-mandata destro A4 scost.13 mm argento			destro	250	8 x 24	20	214455^{1,2}
Scontri ad angolo scrocco-mandata sinistro A4 scost.13 mm argento			sinistro	250	8 x 24	20	A 214456^{1,2}
Scontro scrocco-mandata ad angolo per serratura autobloccante destro per legno argento			destro	250	8 x 24	20	218901^{1,2}
Scontro scrocco-mandata ad angolo per apriporta elettrico destro A4 scost.13 mm argento			destro	250	32 x 25	20	360614*
Scontro scrocco-mandata ad angolo per serratura autobloccante sinistro per legno argento			sinistro	250	8 x 24	20	218902^{1,2}
Scontro scrocco-mandata ad angolo per apriporta elettrico sinistro A4 scost.13 mm argento			sinistro	250	32 x 25	20	B 360615*

¹ Utilizzabile con terminale 362920 per A12.

² Utilizzabile con coprifresata 360397



7.1.3.3 Scontri per nottolino A4			L	B	H		Nº
argento	destro	per A4 scost. 13 mm pressione - 1 mm	90	22	8	200	357671
	sinistro	per A4 scost. 13 mm pressione - 1 mm	90	22	8	200	A 357672



7.1.3.4 Scontri per fungo A4			L	B	H		Nº
argento	destro	per A4 scost. 13 mm con vite inclinata	90	22	8	100	357673¹
		per A4 scost. 13 mm con vite inclinata pressione - 1 mm	90	22	8	100	360102^{1,2*}
	sinistro	per A4 scost. 13 mm con vite inclinata	90	22	8	100	357674¹
		per A4 scost. 13 mm con vite inclinata pressione - 1 mm	90	22	8	100	A 360103^{1,2}

¹ Per porte destre usare scontri sinistri e viceversa!

² Senza conformità con la norma EN 1627



7.1.3.5 Scontri per gancio-punzone			L	B	H		Nº
argento	Scontro gancio-punzone A4 scost. 13 mm		180	22	8	20	A 209909¹

¹ Utilizzabile con coprifresata 358024

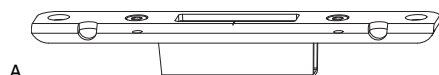

A

7.1.3.6 Scontri ad angolo per gancio-punzone

L

a b



Nº

Scontro gancio-punzone A4 scost.13 mm argento

180

8 x 24

20

A

214459¹

¹ Utilizzabile con terminale 362920 per A12.



A

7.1.3.7 Scontri ad angolo per scrocco-punzone

L

a b



Nº

Scontro scrocco punzone 24x8 A4 Scostamento 13

250

8 x 24

20

A

214457^{1,2,3}

¹ Utilizzabile con terminale 362920 per A12.

² Utilizzabile con copriforo 363959

³ Utilizzabile con coprifresata 364326



A

7.1.3.8 Scontri per scrocco

L

B

H



Nº

argento

Scontro scrocco A4 scost.13 mm

180

22

8

20

A

211597



A

7.1.3.9 Scontri ad angolo per scrocco

L

a b



Nº

Scontro per scrocco elettrico dx+sx per A4 scostamento 13 L=24 argento

130

8 x 24

20

A

214458¹

¹ Utilizzabile con terminale 362920 per A12.

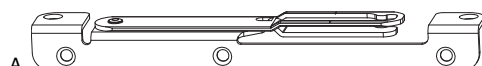

A

7.1.3.10 Scontri per delimitatore d'apertura

L

a b



Nº

Scontro per delimitatore d'apertura destro A4 scost.13 mm argento

destro

200

20 x 24

20

216863*

Scontro per delimitatore d'apertura sinistro A4 scost.13 mm argento

sinistro

200

20 x 24

20

A

216864*



A

B

7.1.3.11 Scontri catenaccio puntale 10x5

L

B

H



Nº

argento

Scontro punzone A4 scost.13 mm

180

22

8

20

A

209911

Scontro catenaccio 2 fori A4 scost.13 mm

180

22

8

20

B

209912



A

7.1.3.12 Scontri catenaccio puntale 8x4

L

B

H



Nº

argento

per A4 scost. 13 mm 2 fori

90

22

9

100

A

209338

7.1.4 Scontri A12 scostamento 9 mm

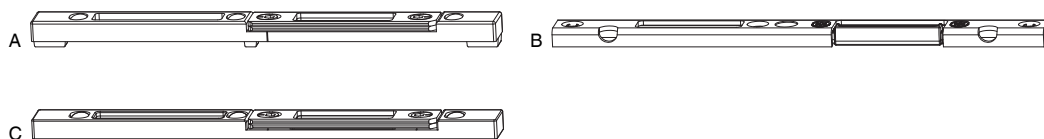

7.1.4.1 Scontri per scrocco-mandata			L	B	H		Nº
argento	destro	Scontro scrocco-mandata per canalino euro 6/8x4	208	18	9	50	58646¹
		Scontro scrocco-mandata per canalino euro 7/8x4	208	18	9	20	58648¹
		Scontro scrocco-mandata per serratura autobloccante A12 scost.9	220	18	8	20	219233
	sinistro	Scontro scrocco-mandata per canalino euro 6/8x4	208	18	9	50	58647¹
		Scontro scrocco-mandata per canalino euro 7/8x4	208	18	9	20	A 58649¹
		Scontro scrocco-mandata per serratura autobloccante A12 scost.9	220	18	8	20	B 219234
		Scontro scrocco-mandata battuta liscia	208	18	9	50	C 55987¹

¹ Utilizzabile con coprifresata 43524

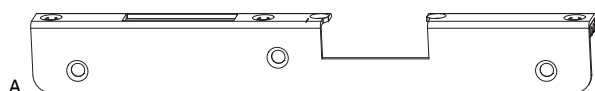

7.1.4.2 Scontri ad angolo scrocco-mandata			L			Nº
argento	destro	Scontro scrocco-mandata ad angolo per apriporta elettrico battuta liscia/18	250	32 x 18	20	210813
	sinistro	Scontro scrocco-mandata ad angolo per apriporta elettrico battuta liscia/18	250	32 x 18	20	A 210814

7.1.4.3 Scontri a U scrocco-mandata per apriporta elettrico			L	B		Nº
argento	destro	Scontro scrocco-mandata per apriporta elettrico battuta liscia	245	22	1	K702501
		Scontro scrocco-mandata per apriporta elettrico per canalino euro 7/8x4	245	24	1	K705607*
	sinistro	Scontro scrocco-mandata per apriporta elettrico battuta liscia	245	22	1	K702505
		Scontro scrocco-mandata per apriporta elettrico per canalino euro 7/8x4	245	24	1	K705608*



7.1.4.4 Scontri per nottolino			L	B	H		Nº
argento	per canalino euro 7/8x4 pressione - 1 mm		48	16	8	200	A 34969*
	per canalino euro 6/8x4 pressione - 1 mm		48	16	8	200	34979
	battuta liscia/18 con vite inclinata		48	17	9	200	B 34980
	battuta liscia/18 2 fori vite		49	17	9	200	C 34943



7.1.4.5 Scontri per fungo		L	B	H		No	
argento	battuta liscia/18 con vite inclinata pressione -0,7 mm	68	18	9	100	A	96660
	battuta liscia/18 con vite inclinata	68	18	9	100		96860
	per canalino euro 6/8x4 con vite inclinata	68	18	9	100	B	96563
	per canalino euro 7/8x4 con vite inclinata	68	18	9	100		96564
	per canalino euro 6/8x4 pressione - 1 mm	68	18	9	100	C	96263
	per canalino euro 7/8x4 con vite inclinata pressione - 1 mm	68	18	9	100		96264



7.1.4.6 Scontri per gancio-punzone		L	B	H		No	
argento	Scontro gancio-punzone per aria 4mm	180	18	8	20	A	207862 ^{1,2}

¹ Deve essere utilizzato con terminale 43718!
² Utilizzabile con coprifresata 358024



7.1.4.7 Scontri per scrocco-punzone		L	B		No	
argento	destro Scontro scrocco-punzone A12 scost.9	180	18	20		218941
	sinistro Scontro scrocco-punzone A12 scost.9	180	18	20	A	218942

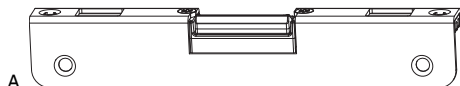

7.1.4.8 Scontri ad angolo per scrocco-punzone		L			No	
argento	Scontro scrocco - punzone ad angolo con inserto scrocco A12 scost.9	190	32 x 18	20	A	214965*



7.1.4.9 Scontri per scrocco		L	B	H		No	
argento	Scontro scrocco per serratura automatica A4 scost.9 mm	120	18	8	20	A	210501 ¹

¹ Deve essere utilizzato con terminale 360074!

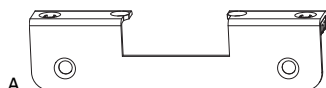

7.1.4.10 Scontri ad angolo per scrocco		L			No	
argento	Scontro ad angolo per scrocco elettrico battuta liscia/18	130	32 x 18	20	A	213325*



7.1.4.11 Scontri per scrocco portafinestra		L	B	H		Nº
argento	battuta liscia/18 regolabile	80	17	6,5	50	A 38924
	per canalino euro 7/8x4 regolabile	80	17	6,5	50	B 55252
	per canalino euro 6/8x4 regolabile	80	17	6,5	50	C 94322*

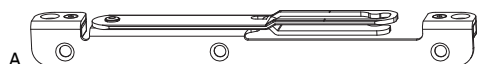

7.1.4.12 Scontri per delimitatore d'apertura			L			Nº
argento	destro	Scontro per delimitatore d'apertura A12 scost.9	200	20 x 18	20	212940*
	sinistro	Scontro per delimitatore d'apertura A12 scost.9	200	20 x 18	20	A 212941*



7.1.4.13 Scontri catenaccio puntale 10x5		L	B	H		Nº
argento	Scontro punzone per canalino euro 7/8x4	84	18	8	20	A 26617
	Scontro punzone battuta liscia	84	18	8	20	B 58667
	Scontro catenaccio 2 fori battuta liscia	120	18	8	20	C 55986
	Scontro catenaccio 2 fori per canalino euro 7/8x4	120	18	8	20	D 50579

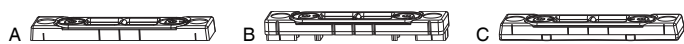

7.1.4.14 Scontri catenaccio puntale 8x4		L	B	H		Nº
argento	battuta liscia/18 2 fori H=6,5 mm	80	17	6,5	100	A 23731
	canalino Euro 2 fori	80	17	6,5	100	B 23886
	battuta liscia/18 2 fori H=7,5 mm	80	17	7,5	100	C 26755

7.1.5 Scontri A12 scostamento 10 mm



7.1.5.1 Scontri per scrocco-mandata

		L	B	H		Nº
argento	Scontro scrocco-mandata per aria 4mm	208	20	8	50	A 29787 ^{1,2}

¹ Deve essere utilizzato con terminale 354358!

² Utilizzabile con coprifresata 43524



7.1.5.2 Scontri per nottolino

		L	B	H		Nº
argento	battuta liscia/20 con vite inclinata	48	19	9	200	A 34981



7.1.5.3 Scontri per fungo

		L	B	H		Nº
argento	battuta liscia/20 con vite inclinata pressione -0,7 mm	68	20	9	100	A 96861
	battuta liscia/20 con vite inclinata	68	20	9	100	96561



7.1.5.4 Scontri per gancio-punzone

		L	B	H		Nº
argento	dx+sx Scontro gancio-punzone per aria 4mm	180	20	8	20	A 207861 ^{1,2}

¹ Deve essere utilizzato con terminale 354358!

² Utilizzabile con coprifresata 358024



7.1.5.5 Scontri per scrocco

		L	B	H		Nº
argento	Scontro scrocco per aria 4mm	120	20	8	20	A 210502 ¹

¹ Deve essere utilizzato con terminale 354358!

7.1.6 Scontri A12 scostamento 13 mm

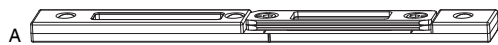

7.1.6.1 Scontri per scrocco-mandata

			L	B	H		Nº
argento	destro	Scontro scrocco-mandata PB 24 mm scost. 13 mm	208	23	9	50	209809 ¹
	sinistro	Scontro scrocco-mandata PB 24 mm scost. 13 mm	208	23	9	50	A 209810 ¹

¹ Utilizzabile con coprifresata 43524

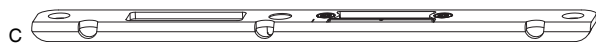
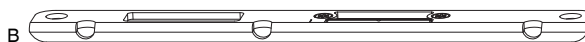
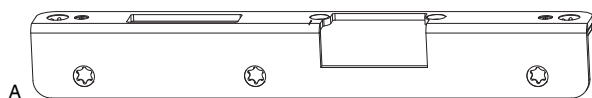

7.1.6.2 Scontri ad angolo scrocco-mandata

			L			Nº
argento	destro	Scontro scrocco-mandata ad angolo per apriporta elettrico per A12 scost. 13 mm	250	33 x 24	20	210016
		Scontri ad angolo scrocco-mandata A4 scost. 13 mm	250	8 x 24	20	214455 ^{1,2}
		Scontro scrocco-mandata ad angolo per serratrua autobloccante per legno	250	8 x 24	20	218901 ^{1,2}
	sinistro	Scontro scrocco-mandata ad angolo per apriporta elettrico per A12 scost. 13 mm	250	33 x 24	20	A 210017
		Scontri ad angolo scrocco-mandata A4 scost. 13 mm	250	8 x 24	20	B 214456 ^{1,2}
		Scontro scrocco-mandata ad angolo per serratrua autobloccante per legno	250	8 x 24	20	C 218902 ^{1,2}

¹ Deve essere utilizzato con terminale 362920!

² Utilizzabile con coprifresata 360397



7.1.6.3 Scontri per nottolino

			L	B	H		Nº
argento	PB 24 mm scost. 13 mm con vite inclinata		48	23	9	200	A 34934



7.1.6.4 Scontri per fungo

			L	B	H		Nº
argento	PB 24 mm scost. 13 mm senza anello di rinforzo con vite inclinata		68	23	9	100	364952
	PB 24 mm scost. 13 mm senza anello di rinforzo con vite inclinata pressione - 1 mm		68	23	9	100	A 364953



7.1.6.5 Scontri per gancio-punzone

			L	B	H		Nº
argento	Scontro gancio-punzone per A12 scost. 13 mm		180	23	8	20	A 210779 ¹

¹ Utilizzabile con coprifresata 358024

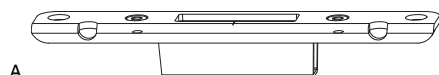

7.1.6.6 Scontri ad angolo per gancio-punzone

		L	a	b		No
argento	Scontro gancio-punzone A4 scost.13 mm	180	8 x 24	20	A	214459 ¹

¹ Deve essere utilizzato con terminale 362920!



7.1.6.7 Scontri ad angolo per scrocco-punzone

		L	a	b		No
argento	Scontro scrocco - punzone ad angolo con inserto scrocco A4 scost.13 mm	250	8 x 24	20	A	214457 ^{1,2,3}

¹ Utilizzabile con copriforo 363959

² Deve essere utilizzato con terminale 362920!

³ Utilizzabile con coprifresata 364326



7.1.6.8 Scontri per scrocco

		L	B	H		No
argento	Scontro scrocco per serratura automatica legno A12/PB24-sc.13	180	23	8	A	211598



7.1.6.9 Scontri ad angolo per scrocco

		L	a	b		No
argento	Scontro per scrocco elettrico A4 scost.13 mm	130	8 x 24	20	A	214458 ¹

¹ Utilizzabile con terminale 362920 per A12.



7.1.6.10 Scontri per scrocco portafinestra

		L	B	H		No
argento	PB 24 mm scost. 13 mm regolabile	80	23	6,5	A	209347

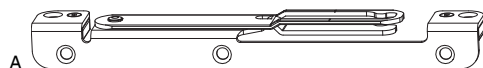

7.1.6.11 Scontri per delimitatore d'apertura

		L	a	b		No
argento	destro Scontro per delimitatore d'apertura A12 scost.13 mm	200	20 x 24	20		216865*
	sinistro Scontro per delimitatore d'apertura A12 scost.13 mm	200	20 x 24	20	A	216866*



7.1.6.12 Scontri catenaccio puntale 10x5

		L	B	H		No
argento	Scontro catenaccio 2 fori per A12 scost. 13 mm	180	23	8	A	210782
	Scontro punzone PB 24 mm scost. 13 mm	180	23	8	B	210781

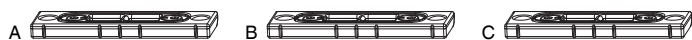

7.1.6.13 Scontri catenaccio puntale 8x4		L	B	H		N°	
argento	PB 24 mm scost. 13 mm 2 fori	80	23	6,5	100	A	203329
	PB 24 mm scost. 13 mm 2 fori avvitamento inclinato pressione + 1 mm	80	23	6,5	100	B	211369
	PB 24 mm scost. 13 mm 2 fori avvitamento inclinato	80	23	7,7	100	C	212474

7.2 Scontri cava ferramenta contrapposta

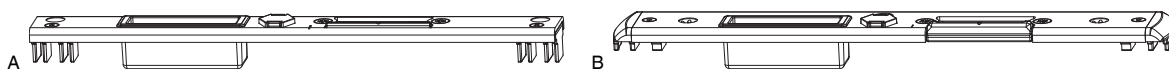

7.2.1 Scontri per scrocco-mandata			L	B	H		Nº	
argento	destro	Scontro scrocco-mandata cava ferramenta contrapposta	175	18	9	50		58674
		Scontro scrocco-mandata cava ferramenta contrapposta pressione - 1 mm	175	18	9	50		58714*
		Scontro scrocco-mandata per serratura autobloccante per PVC	235	24	8	20		226489*
		Scontro scrocco-mandata cava ferramenta contrapposta	235	24	8	20		215197
		Scontro scrocco-mandata AE per apriporta elettrico per PVC	250	32	8	20		209104
		Scontro scrocco-mandata per serratura autobloccante per PVC	250	32	8	20		219258
	sinistro	Scontro scrocco-mandata cava ferramenta contrapposta	175	18	9	50		58675
		Scontro scrocco-mandata cava ferramenta contrapposta pressione - 1 mm	175	18	9	50		58715
		Scontro scrocco-mandata per serratura autobloccante per PVC	235	24	8	20	A	226490*
		Scontro scrocco-mandata cava ferramenta contrapposta	235	24	8	20		215201
		Scontro scrocco-mandata AE per apriporta elettrico per PVC	250	32	8	20		209105
		Scontro scrocco-mandata per serratura autobloccante per PVC	250	32	8	20	B	219259

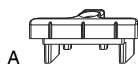

7.2.2 Scontri per nottolino			L	B	H		Nº	
argento	cava ferramenta contrapposta pressione - 1 mm		48	19	8	200		34606
	cava ferramenta contrapposta		48	17	8	200	A	34610
	cava ferramenta contrapposta pressione -2 mm		48	19	8	200		94463*

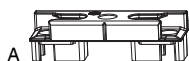

7.2.3 Scontri per fungo			L	B	H		Nº	
argento	destro	Scontro per fungo per PVC	80	30	8	20		354987*
	sinistro	Scontro per fungo per PVC	80	30	8	20		355000*
		cava ferramenta contrapposta pressione - 0,8 mm	68	20	9	100	A	96558



7.2.4 Scontri per gancio-punzone			L	B	H		Nº	
argento	Scontro gancio-punzone per PVC		160	29,5	8	20		211544
	Scontro gancio-punzone per cava ferramenta		180	18	8	20	A	217676*

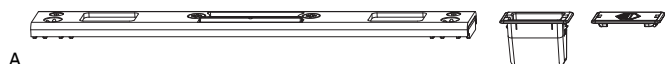

A

7.2.5 Scontri per scrocco-punzone			L	B	H		Nº
argento	destro	Scontro scrocco-punzone per PVC	220	32	7	20	215425
	sinistro	Scontro scrocco-punzone per PVC	220	32	7	20	215424
		Scontro scrocco-punzone per profilo MD per PVC	200	24		20	A 103413



A

7.2.6 Scontri per scrocco			L	B	H		Nº
argento		Scontro scrocco con inserto cava ferramenta contrapposta	120	24		20	A 215497*
		Scontro scrocco per cava ferramenta	150	32	7	20	209979



A

7.2.7 Scontri per scrocco portafinestra			L	B	H		Nº
argento		per cava ferramenta	80	17	6,5	50	A 35250



A

7.2.8 Scontri per delimitatore d'apertura			L	B		Nº
argento	sinistro	Scontro per delimitatore d'apertura per PVC	240	32	20	A 214380*

7.3 Asta scontri legno



7.3.1 Asta Scontri legno U-6x24x6 scostamento 13mm					B		L		Nº	
argento	destro	Asta scontri PB 24 mm scost. 13 mm	2 ganci - punzoni	6	24	6	2.200	5	A	214190 ^{1,2}
			2 scrocchi-ganci	6	24	6	2.200	5		218784 ^{2,3}
			2 scrocchi-ganci K+605	6	24	6	2.035	5	B	224649 ^{2,3}
			2 scrocchi-ganci K+980	6	24	6	2.200	5		224651 ^{2,3}
			2 scrocchi- punzoni	6	24	6	2.200	5		215907 ^{2,4}
			2 scrocchi- punzoni K+605	6	24	6	2.035	5		215911 ^{2,4}
			2 scrocchi- punzoni K+980	6	24	6	2.200	5		215909 ^{2,4}
	4 funghi	6	24	6	2.400	5		102850 ²		
	4 ganci - punzoni	6	24	6	2.200	5		226733 ^{1,2}		
	sinistro	Asta scontri PB 24 mm scost. 13 mm	2 ganci - punzoni	6	24	6	2.200	5		214191 ^{1,2}
			2 scrocchi-ganci	6	24	6	2.200	5		218785 ^{2,3}
			2 scrocchi-ganci K+605	6	24	6	2.035	5		224650 ^{2,3}
			2 scrocchi-ganci K+980	6	24	6	2.200	5		224652 ^{2,3}
			2 scrocchi- punzoni	6	24	6	2.200	5		215908 ^{2,4}
2 scrocchi- punzoni K+605			6	24	6	2.035	5		215912 ^{2,4}	
2 scrocchi- punzoni K+980			6	24	6	2.200	5		215910 ^{2,4}	
4 funghi	6	24	6	2.400	5		102851 ²			
4 ganci - punzoni	6	24	6	2.200	5		226734 ^{1,2}			

¹ Viene utilizzato con serratura comando cilindro modulare Z-TS

² Utilizzabile con copri vite 362704

³ Viene utilizzato con serratura autobloccante Z-TA

⁴ Viene utilizzato con serratura automatica comando cilindro Z-TF

7.4 Scontri PVC

7.4.1 Scontri e aste scontri per serratura autobloccante

Profili	Scontro scrocco-mandata per serratura autobloccante destro	Scontro scrocco-mandata per serratura autobloccante sinistro	Scontro scrocco-gancio	Asta scontri 2 scrocci-ganci destra	Asta scontri 2 scrocci-ganci sinistra	Asta scontri 2 scrocci-ganci K+605 destra	Asta scontri 2 scrocci-ganci K+605 sinistra	Asta scontri 2 scrocci-ganci K+980 destra	Asta scontri 2 scrocci-ganci K+980 sinistra
In Alpha 70 Prestigio	225715	225716	225717	-	-	-	-	-	-
Aluplast 2000	219431	219432	219433	219429	219430	219436	219437	219434	219435
Aluplast 4000/5000/6000	217924	217925	217930	217920	217921	217922	217923	217926	217927
Cava ferramenta contrapposta	219258	219259	219260	219225	219226	219227	219228	219229	219230
Brüggmann AD	217936	217937	217941	217932	217933	217934	217935	217938	217939
Bruggmann AD scostamento 20 mm	219261	219262	219263	219492	219493	219494	219495	219496	219497
Deceuninck Zendow	219320	219321	219322	219318	219319	219325	219326	219323	219324
Gealan S 3000/7000/8000	217914	217915	217918	217910	217911	217912	217913	217916	217917
Inoutic AD	219252	219253	219254	219210	219211	219212	219213	219214	219215
Inoutic Prestige	219252	219253	219254	219210	219211	219212	219213	219214	219215
KBE System 70 AD	224097	224098	224064	226482	226483	226484	226485	226486	226487
Kömmerling Eurofutur/Eurodur	217947	217948	217951	217943	217944	217945	217946	217949	217950
Kömmerling Eurofutur 88+ MD	217947	217948	217951	217943	217944	217945	217946	217949	217950
Rehau S 730	219249	219250	219251	219204	219205	219206	219207	219208	219209
Rehau Tritec/S706 New	224039	224040	224059	-	-	-	-	-	-
Rehau Geneo	217957	217958	217961	217953	217954	217891	217982	217903	217904
Salamander 2D/3D	217924	217925	217930	217920	217921	217922	217923	217926	217927
Salamander bluEvolution	217957	217958	217961	217953	217954	217891	217892	217903	217904
Salamander Streamline	217924	217925	217930	217920	217921	217922	217923	217926	217927
Schüco Corona AS	219431	219432	219433	219429	219430	219436	219437	219434	219435
Schüco CT 70 - AS	219431	219432	219433	219429	219430	219436	219437	219434	219435
Schüco Si 82	219431	219432	219433	219429	219430	219436	219437	219434	219435
Trocal Innonova A3	219255	219256	219257	219216	219217	219218	219219	219220	219221
Trocal Innonova A5	219255	219256	219257	219216	219217	219218	219219	219220	219221
Trocal Innonova Confort	219255	219256	219257	219216	219217	219218	219219	219220	219221
Trocal Innonova 2000 MD	224800	224801	213190	224794	224795	224796	224797	224798	224799
Trocal 88+ MD	224800	224801	213190	224794	224795	224796	224797	224798	224799
Veka Softline/Topline con cava ferramenta	217936	217937	217941	217932	217933	217934	217935	217938	217939
Veka Softline/Topline senza cava ferramenta	219499	219500	219501	224083	224084	224085	224086	224087	224088
Veka Softline/Topline senza cava ferramenta larghezza 44 mm	226075	226076	226077	226061	226062	226063	226064	226065	226066
Veka Softline/Topline senza cava ferramenta larghezza 44mm pressione -1 mm	226094	226095	226096	226080	226081	226082	226083	226084	226085
Veka cava ferramenta contrapposta scost. 15 mm	227386	227387	224923	-	-	-	-	-	-
Wymar Profex 3000	219361	219362	219363	219359	219360	219366	219367	219364	219365

7.4.2 Scontri e aste scontri per serratura comando maniglia/comando cilindro modulare

Profili	Scontro scrocco-man-data per apriporta elettrico destra	Scontro scrocco-man-data per apriporta elettrico sinistra	Scontro gancio-punzone	Scontro per delimitatore d'apertura destra	Scontro per delimitatore d'apertura sinistra	Asta scontri per 2 ganci-punzoni destro	Asta scontri per 2 ganci-punzoni sinistro	Asta scontri 2 ganci - punzoni K+605 destro	Asta scontri 2 ganci - punzoni K+605 sinistro	Asta scontri 2 ganci - punzoni K+980 destro	Asta scontri 2 ganci - punzoni K+980 sinistro	Asta scontri AE per 4 ganci-punzoni destro	Asta scontri per 4 ganci-punzoni sinistro	Coprifresata per scontro gancio-punzone	Coprifresata per scontro catenaccio 2 fori
Alphacan MD	-	-	-	-	-	213986	213987	-	-	-	-	-	-	358027	355403
Aluplast 2000	209094	209095	211557*	-	-	211630	211631	-	-	-	-	225053	225054	358027	355403
Aluplast 4000/5000/6000	209099	209100	211543*	212934*	212935*	211632	211633	-	-	-	-	225049	225050	358027	355403
Cava ferramenta contrapposta	209104	209105	211544*	214379*	214380*	211634	211635	-	-	-	-	213658	213659	358027	355403
Brüggmann AD	209109	209110	211545*	214367*	214368*	211636	211637	-	-	-	-	225864	225865	358027	355403
Bruggmann AD scostamento 20 mm	209114	209115	211546*	-	-	-	-	-	-	-	-	225860	225861	358027	355403
Deceuninck 800 scostamento 21 mm	209119	209120	211548*	-	-	-	-	-	-	-	-	-	-	358027	355403
Deceuninck Zendow	209124	209125	211549*	-	-	208473	208472	-	-	-	-	213663	213664	358027	355403
Dimex Komfort	209099	209100	211543*	-	-	211632	211633	-	-	-	-	213656	213657	358027	355403
Duraflex X 3500	209129	209130	-	-	-	-	-	-	-	-	-	-	-	358027	355403
Gealan S 3000/7000/8000	209134	209135	211550*	214369*	214370*	207832	207833	-	-	-	-	225057	225058	358027	355403
Greiner Intertec	209699	209700	211541*	-	-	-	-	-	-	-	-	-	-	358027	355403
Inoutic AD	209179	209180	211555*	209094*	-	208464	208465	-	-	-	-	225880	225881	358027	355403
Inoutic Prestige	209179	209180	211555*	-	-	208464	208465	-	-	-	-	225880	225881	358027	355403
KBE System 70 AD	209139	209140	211551*	215432*	215433*	-	-	-	-	-	-	-	-	358027	355403
Kömmerling Eurofutur/Eurodur	-	-	-	-	-	-	-	-	-	216018	216019	-	-	-	-
Kömmerling Eurofutur 88+ MD	215199*	215204*	211552*	214377*	214378*	213933*	213934	-	-	-	-	-	-	358027	355403
Kömmerling Gold 70	209139	209140	211551*	215432*	215433*	-	-	-	-	-	-	-	-	358027	355403
Rehau S 730	209159	209160	211553*	214373*	214374*	208599	208600	-	-	-	-	213668	213669	358027	355403
Rehau Geneo/Tritec/S706 New	209164	209165	-	-	-	-	-	-	-	-	-	225041	225042	358027	355403
Salamander 2D/3D	209169	209170	211554*	214371*	214372*	208462	208463	-	-	-	-	225049	225050	358027	355403
Salamander 3D	209169	209170	211554*	214371*	214372*	208462	208463	-	-	-	-	213670	213671	358027	355403
Salamander bluEvolution	213592	213593	213595*	216795*	216796*	213606	213607	-	-	-	-	225045	225046	358027	355403
Schüco Corona AS	209174	209175	211543*	-	-	211632	211633	-	-	-	-	213656	213657	358027	355403
Schüco CT 70 - AS	209094	209095	211557*	-	-	211630	211631	-	-	-	-	225053	225054	358027	355403
Schüco Si 82	-	209095	211557*	-	-	211630	211631	-	-	-	-	213654	213655	358027	355403
Trocal Innonova A3	209184	209185	211556*	214375*	214376*	208466	208467	-	-	-	-	213674	213675	358027	355403
Trocal Innonova A5	209184	209185	211556*	214375*	214376*	208466	208467	-	-	-	-	213674	213675	358027	355403
Trocal Innonova Confort	209184	209185	211556*	-	-	208466	208467	-	-	-	-	213674	213675	358027	355403
Trocal Innonova M5 MD	-	-	-	-	-	213957	213958	-	-	-	-	-	-	358027	355403
Trocal Innonova 2000 MD	215195	215207	213190*	-	-	213945	213946	-	-	-	-	213947	213948	358027	355403
Trocal 88+ MD	215195	215207	213190*	-	-	213945	213946	-	-	-	-	213947	213948	358027	355403
Veka Softline/Topline con cava ferramenta	209109	209110	211545*	214367*	214368*	211636	211637	-	-	-	-	225864	225865	358027	355403
Veka Softline/Topline senza cava ferramenta	219502	219503	219501*	-	-	224089	224090	224091	224092	224093	224094	-	-	-	-
Veka Softline/Topline senza cava ferramenta larghezza 44 mm	226078	226079	226077*	-	-	226067	226068	226088	226089	226090	226091	-	-	-	-
Veka Softline/Topline senza cava ferramenta larghezza 44mm pressione -1 mm	226097	226098	226096*	-	-	226086	226087	226088	226089	226090	226091	-	-	-	-
Veka cava ferramenta contrapposta scost. 15 mm	224921	224922	224923*	-	-	-	-	-	-	-	-	-	-	-	-
Wymar Profex 2500	209194	209195	211561*	-	-	-	-	-	-	-	-	-	-	358027	355403
Wymar Profex 3000	209199	209200	211562*	-	-	-	-	-	-	-	-	-	-	358027	355403
Wymar Profex 3000 girando esternamente	210281	210280	211563*	-	-	-	-	-	-	-	-	-	-	358027	355403

* nessun apriporta elettrico adatto disponibile

7.4.3 Scontri per serratura automatica

Profili	Scontro scrocco- mandata per apri- porta elettrico de- stra	Scontro scrocco- mandata per apri- porta elettrico si- nistra	Scontro scrocco- punzone destro	Scontro scrocco- punzone sinistro	Scontro scrocco- punzone ambi- destro	Copripresata per scontro gancio- punzone
In Alpha 70 Prestigio	-	-	225719	225720	-	-
Aluplast 2000	209094	209095	-	-	-	355399
Aluplast 4000/5000/6000	209099	209100	215550	215551	-	355399
Cava ferramenta contrapposta	209104	209105	215425	215424	-	355399
Brüggmann AD	209109	209110	208601	208602	-	355399
Brugmann AD scostamento 20 mm	209114	209115	-	-	-	355399
Deceuninck 800 scostamento 21 mm	209119	209120	-	-	-	355399
Deceuninck Zendow	209124	209125	216059	216060	-	355399
Dimex Komfort	209099	209100	-	-	-	355399
Duraflex X 3500	209129	209130	-	-	-	355399
Gealan S 3000/7000/8000	209134	209135	215252	215253	-	355399
Greiner Intertec	209699	209700	-	-	-	355399
Inoutic AD	209179	209180	-	-	-	355399
Inoutic E-Forte	228298	228298	228301	228305	-	-
Inoutic Prestige	209179	209180	-	-	-	355399
KBE System 70 AD	209139	209140	216043	216042	-	355399
Kömmerling Eurofutur/Eurodur	209144	209145	215602	215603	-	355399
Kömmerling Eurofutur MD	209144	209145	215602	215603	-	355399
Kömmerling Gold 70	209139	209140	-	-	-	355399
Rehau S 730 / Brilliant Design	209159	209160	215594	215595	-	355399
Rehau Geneo/Tritec/S706 New	209164	209165	217928	217929	-	355399
Salamander 2D/3D	209169	209170	215411	215412	-	355399
Salamander Streamline	209169	209170	215411	215412	-	355399
Salamander bluEvolution	213592	213593	216371	216372	-	355399
Schüco Corona AS	209174	209175	-	-	-	355399
Schüco CT 70 - AS	209094	209095	-	-	-	355399
Schüco CT 70 - MD	-	-	-	-	-	355399
Schüco Si 82	209094	209095	-	-	-	355399
Trocal Innonova A3	209184	209185	216027	216028	-	355399
Trocal Innonova A5	209184	209185	216027	216028	-	355399
Trocal Innonova Confort	209184	209185	216027	216028	-	355399
Trocal 88+ / Innonova 2000	215195	215207	-	-	-	355399
Veka Softline/Topline con cava ferramenta	209109	209110	208601	208602	-	355399
Veka Softline/Topline senza cava ferramenta	-	-	-	-	-	355399
	219502	219503	-	-	224896	-
Wymar Profex 2500	209194	209195	-	-	-	355399
Wymar Profex 3000	209199	209200	-	-	-	355399
Wymar Profex 3000 girando esternamente	210281	210280	-	-	-	355399

* nessun apriporta elettrico adatto disponibile

7.4.4 Aste scontri per serratura automatica

Profili	Asta scontri 2 scrocchi-punzoni destro	Asta scontri 2 scrocchi-punzoni sinistro	Asta scontri 2 scrocchi-punzoni K+605 destro	Asta scontri 2 scrocchi-punzoni K+605 sinistro	Asta scontri 2 scrocchi-punzoni K+980 destro	Asta scontri 2 scrocchi-punzoni K+980 sinistro
Alphacan Class	216324	216325	216326	216327	216328	216329
Alphacan MD	-	-	-	-	-	-
Aluplast 2000	216928	216929	216930	216931	216932	216933
Aluplast 4000/5000/6000	215544	215545	215546	215547	215548	215549
Cava ferramenta contrapposta	-	-	-	-	-	-
Brüggmann AD	215583	215584	215585	215586	215587	215588
Deceuninck Zendow	216053	216054	216055	216056	216057	216058
Dimex Komfort	215544	215545	215546	215547	215548	215549
Gealan S 3000/7000/8000	215312	215313	215314	215315	215316	215317
Inoutic AD	-	-	-	-	-	-
Inoutic E-Forte	-	-	-	-	-	-
Inoutic Prestige	-	-	-	-	-	-
KBE System 70 AD	216049	216048	216047	216046	216045	216044
Kömmerling Avantgarde	215604	215605	215606	215607	215608	215609
Kömmerling Eurofutur AD	215604	215605	215606	215607	215608	215609
Kömmerling Eurodur 3S	215604	215605	215606	215607	215608	215609
Kömmerling Eurofutur MD	215604	215605	215606	215607	215608	215609
Kömmerling Gold 70	-	-	-	-	-	-
Kömmerling 88+	216910	216911	216914	216915	216912	216913
Rehau S 730	215596	215597	215598	215599	215600	215601
Rehau Geneo	216343	216344	217963	217964	217965	217966
Salamander 2D/3D	215402	215403	215404	215405	215406	215407
Salamander Streamline	215402	215403	215404	215405	215406	215407
Salamander bluEvolution	216373	216374	216375	216376	216377	216378
Schüco CT 70 - AS	-	-	-	-	-	-
Schüco Si 82	-	-	-	-	-	-
Inoutic AD	-	-	-	-	-	-
Inoutic Prestige	-	-	-	-	-	-
Trocal Innonova A3	216021	216022	216023	216024	216025	216026
Trocal Innonova A5	216021	216022	216023	216024	216025	216026
Trocal Innonova Confort	216021	216022	216023	216024	216025	216026
Trocal Innonova M5	-	-	-	-	-	-
Trocal Innonova 2000	215898	215899	215902	215903	215900	215901
Trocal 88+	215898	215899	215902	215903	215900	215901
Veka Softline/Topline con cava ferramenta	215583	215584	215585	215586	215587	215588
Veka Softline/Topline senza cava ferramenta	228142	228143	228144	228145	228146	228147
Wymar Profex 2500	-	-	-	-	-	-
Wymar Profex 3000	216300	216301	216302	216303	216304	216305

7.5 Scontri Alu

7.5.1 Scontri Alu 3 mm battuta liscia scost. 13

7.5.1.1 Scontri



7.5.1.1.1 Scontri per scrocco-punzone

		L	B	H		Nº
argento	Scontro scrocco-punzone per alluminio	200	24	3	20	A 216977



7.5.1.1.2 Scontri per scrocco-mandata

		L	B	H		Nº	
argento	destro	Scontro scrocco-mandata per alluminio	250	24	3	20	212282*
		Scontro scrocco-mandata per serratura autobloccante per alluminio	250	24	3	20	219183*
	sinistro	Scontro scrocco-mandata per alluminio	250	24	3	20	A 212283*
		Scontro scrocco-mandata per serratura autobloccante per alluminio	250	24	3	20	B 219184*

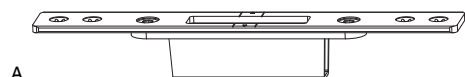

7.5.1.1.3 Scontri gancio-punzone

		L	B	H		Nº
argento	Scontro gancio-punzone per alluminio	190	25	3	20	A 212647*

7.5.1.2 Asta scontri



7.5.1.2.1 Asta scontri scrocco-punzone

			B		L		Nº		
argento	destro	Asta scontri per alluminio	2 scrocchi-punzoni	3	24	3	1.692	5	215231*
			2 scrocchi-punzoni K+605	3	24	3	1.567	5	A 215233*
			2 scrocchi-punzoni K+980	3	24	3	1.942	5	215235*
	sinistro	Asta scontri per alluminio	2 scrocchi-punzoni	3	24	3	1.692	5	215232*
			2 scrocchi-punzoni K+605	3	24	3	1.567	5	215234
			2 scrocchi-punzoni K+980	3	24	3	1.942	5	215236*



7.5.1.2.2 Asta scontri gancio-punzone

			B		L		Nº		
argento	destro	Asta scontri per alluminio	2 ganci-punzoni	3	24	3	1.680	5	214466*
	sinistro	Asta scontri per alluminio	2 ganci-punzoni	3	24	3	1.680	5	A 214467*

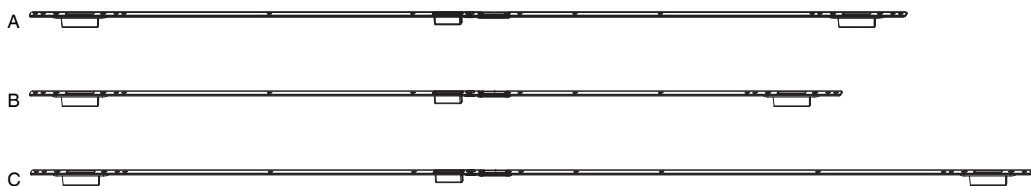

7.5.1.2.3 Asta scontri scrocco-gancio					B		L			Nº
argento	destro	Asta scontri per alluminio	2 scrocchi-ganci	3	24	3	1.680	5	A	219038*
			2 scrocchi-ganci K+605	3	24	3	1.555	5	B	219040*
			2 scrocchi-ganci K+980	3	24	3	1.930	5	C	219042*
	sinistro	Asta scontri per alluminio	2 scrocchi-ganci	3	24	3	1.680	5		219039*
			2 scrocchi-ganci K+605	3	24	3	1.555	5		219041*
			2 scrocchi-ganci K+980	3	24	3	1.930	5		219043*

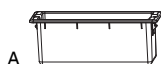

7.5.1.3 Accessori				Nº
Copertura Scontro scrocco-punzone nero			100	363959
Coprifresata scontro scrocco-punzone per apriporta elettrico -30,7x nero			100	364326
Coprifresata serratura per scontro scrocco-mandata nero			50	A 360397

7.5.2 Scontri Alu 3 mm scost.10 canalino 14mm

7.5.2.1 Scontri

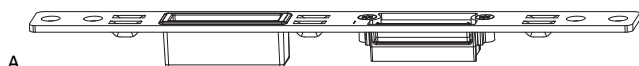

7.5.2.1.1 Scontri per scrocco-mandata			L	B	H		Nº	
argento	destro	Scontro scrocco-mandata per ALU canalino 14mm	270	24	3	20	A	214407*
		Scontro scrocco-mandata per serratura autobloccante per ALU canalino 14mm	270	24	3	20		219036*
	sinistro	Scontro scrocco-mandata per ALU canalino 14mm	270	24	3	20		214408*
		Scontro scrocco-mandata per serratura autobloccante per ALU canalino 14mm	270	24	3	20		219037*



7.5.2.1.2 Scontri gancio-punzone			L	B	H		Nº	
argento	Scontro gancio-punzone per ALU canalino 14mm		190	25	3	20	A	214409*



7.5.2.1.3 Scontri scrocco-punzone			L	B	H		Nº	
argento	Scontro scrocco-punzone per ALU canalino 14mm		270	24	3	20	A	228856*

7.5.3 Scontri Alu U-6/24/6 scost. 13

7.5.3.1 Scontri



7.5.3.1.1 Scontri per scrocco-mandata				B		L		Nº
argento	destro	Scontro scrocco-mandata AE per apriporta elettrico per PVC	6	24	6	235	20	213240*
		Scontro scrocco-mandata per serratura autobloccante per alluminio	6	24	6	240	20	224969^{1*}
	sinistro	Scontro scrocco-mandata AE per apriporta elettrico per PVC	6	24	6	235	20	213241*
		Scontro scrocco-mandata per serratura autobloccante per alluminio	6	24	6	240	20	A 224970^{1*}

¹ Utilizzabile con apriporta elettrico 477421



7.5.3.1.2 Scontri gancio-punzone		L	B	H		Nº
argento	Scontro gancio-punzone per alluminio	160	24	6	20	A 213180¹

¹ Utilizzabile con coprifresata 358027



7.5.3.1.3 Scontri per scrocco-punzone				B		L		Nº
argento	Scontro scrocco-punzone per alluminio		6	24	6	200	20	A 102998



7.5.3.1.4 Scontri per delimitatore d'apertura			B	L		Nº
argento	Scontro per delimitatore d'apertura per alluminio	destro	24	220	20	216754
		sinistro	24	220	20	A 216755

7.5.3.2 Asta scontri



7.5.3.2.1 Asta scontri gancio-punzone					B		L		Nº
argento	Asta scontri	destro	4 ganci - punzoni	6	24	6	1.850	5	A 208470¹
			2 ganci - punzoni	6	24	6	1.850	5	208468
	sinistro	4 ganci - punzoni	6	24	6	1.850	5	208471¹	
		2 ganci - punzoni	6	24	6	1.850	5	208469	

¹ Utilizzabile con apriporta elettrico 477421



7.5.3.2.2 Asta scontri scrocco-gancio					B		L		N°
argento	Asta scontri	destro	2 scrocci-ganci K+605	6	24	6	1.725	5	224973 ¹
			2 scrocci-ganci K+980	6	24	6	2.105	5	224975 ¹
			2 scrocci-ganci	6	24	6	1.855	5	A 224971 ¹
	sinistro	2 scrocci-ganci	6	24	6	1.855	5	224972 ¹	
		2 scrocci-ganci K+605	6	24	6	1.725	5	224974 ¹	
		2 scrocci-ganci K+980	6	24	6	2.105	5	224976 ¹	

¹ Utilizzabile con apriporta elettrico 477421

7.5.4 Scontri Alu scost.9 canalino 14 mm

7.5.4.1 Scontri per porte ad 1 anta



7.5.4.1.1 Scontri per scrocco-mandata					B		L		N°
argento	Scontro scrocco-mandata per serratura autobloccante A12 scost.9	destro	8	18	8	220	20	A	228816*
		sinistro	8	18	8	220	20	228817*	
		Scontro scrocco-mandata per ALU canalino 14mm	dx+sx		18		208	50	212820

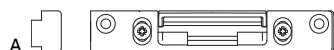

7.5.4.1.2 Scontri per scrocco				B	L		N°	
argento	Scontro scrocco			18	107,2	18	50	A 212371



7.5.4.1.3 Scontri per scrocco-punzone					B		L		N°
argento	Scontro scrocco-punzone per canalino euro 7/8x4	destro	8	18	8	180	20	A	228814*
		sinistro	8	18	8	180	20	228815*	



7.5.4.1.4 Scontri gancio-punzone				L	B	H		N°
argento	dx / sx	Scontro gancio-punzone per alluminio		180	18	6	20	A 215785



7.5.4.1.5 Scontri catenaccio				L	B	H		N°
argento	Scontro catenaccio 2 fori per canalino euro 7/8x4			120	18	8	20	A 50579



7.5.4.1.6 Scontri fungo		L	B	H		Nº
argento	per alluminio	68	19	9	100	A 356361



7.5.4.1.7 Scontri		L	B	H		Nº
argento	per alluminio	48	19	8	200	A 356362
	Scontro nottolino pressione - 1 mm	48	19,5		100	361453*

7.5.5 Scontri Alu scost.13 canalino 14 mm

7.5.5.1 Scontri per porte ad 1 anta



7.5.5.1.1 Scontri per scrocco-mandata				B		L		Nº
argento	Scontro scrocco-mandata per serratura autobloccante per alluminio pressione -2 mm	destro	6	24	6	235	20	A 228443 ^{1*}
	Scontro scrocco-mandata per profilo MD per PVC	destro	6	24	6	235	20	224409 ^{1*}
	Scontro scrocco-mandata per serratura autobloccante per alluminio pressione -2 mm	sinistro	6	24	6	235	20	228444 ^{1*}
	Scontro scrocco-mandata per profilo MD per PVC	sinistro	6	24	6	235	20	224410 ¹

¹ Utilizzabile con apriporta elettrico 477421



7.5.5.1.2 Asta scontri scrocco-gancio			B			Nº
argento	Scontro scrocco-gancio per PVC pressione -2 mm	6	24	6	20	A 228445*



7.5.5.1.3 Scontri per scrocco-punzone			B		L		Nº
argento	Scontro scrocco-punzone per alluminio	6	24	6	200	20	A 228446



7.5.5.1.4 Scontri per scrocco			B			Nº
argento	Scontro scrocco per profilo MD pressione -1 mm	6	24	6	20	A 219269 ^{1*}

¹ Utilizzabile con apriporta elettrico 477421

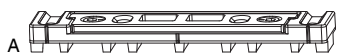

7.5.5.1.5 Scontri catenaccio

L B H 

Nº

argento Scontro catenaccio 2 fori per alluminio 133 24 8 20 A **228850***



7.5.5.1.6 Scontri fungo

L B H 

Nº

argento per alluminio 68 22 9 100 A **360694**



7.5.5.1.7 Scontri

L B H 

Nº

argento per alluminio 48 22,5 8 200 A **360693***

8 Asta a leva

8.1	Composizione asta a leva	78
8.2	Asta a leva	79
8.2.1	Aste a leva per legno scostamento 13 mm profondità battuta 24 mm U-8x24x8	79
8.2.2	Aste a leva per legno scostamento 13 mm profondità battuta 28 mm U-8x28x8	79
8.2.3	Asta a leva scostamento 13 mm U-8x28x8 cava ferramenta contrapposta	80
8.2.4	Aste a leva 4 funghi HM1050 F16	80
8.2.5	Prolunga ferramenta	80
8.2.6	Terminale per asta a leva F16 senza scontro integrato	80
8.2.7	Collegamento asta dentata	80
8.3	Terminale per asta a leva	81
8.3.1	Terminali per legno scostamento 13mm profondità battuta 24 mm U-8x24x8	81
8.3.2	Terminali per legno scostamento 13mm profondità battuta 28 mm U-8x28x8	81
8.3.3	Terminale scostamento 13mm U-8x28x8 per cava ferramenta	81
8.3.4	Terminali per legno profondità battuta 24 mm con scontro scrocco-gancio/gancio-punzone integrato U-8x24x8	81
8.3.5	Terminali per legno profondità battuta 28 mm con scontro scrocco-gancio/gancio-punzone integrato U-8x28x8	82
8.3.6	Terminali con scontro scrocco-gancio/gancio-punzone integrato U-8x28x8 per cava ferramenta contrapposta	82
8.4	Prolunghe per asta a leva	83
8.4.1	Prolunghe per asta a leva scostamento 13mm scontro scrocco-gancio/gancio-punzone integrato U-8x24x8	83
8.4.2	Prolunghe per asta a leva scostamento 13mm scontro scrocco-gancio/gancio-punzone integrato U-8x28x8	83
8.4.3	Prolunghe per asta a leva scostamento 13mm scontro scrocco-gancio/gancio-punzone integrato U-8x28x8 cava ferramenta contrapposta	83

8 Asta a leva

8.1 Composizione asta a leva

Asta a leva con terminale

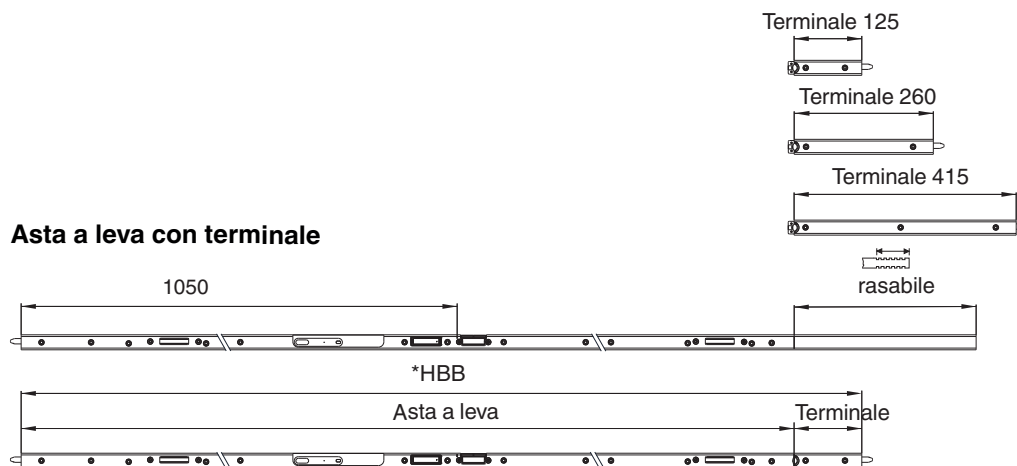

Asta a leva con terminale con scontro gancio-punzone integrato

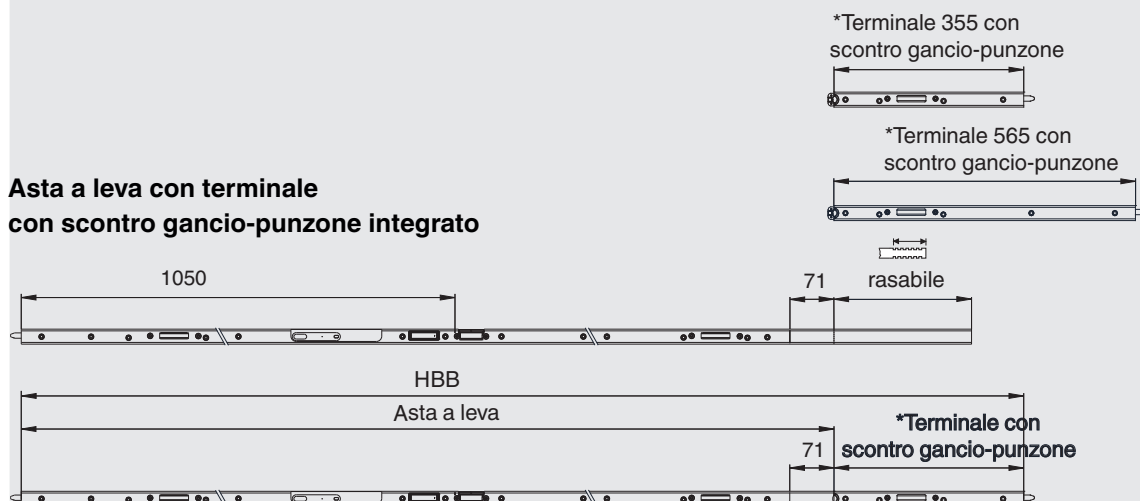

Asta a leva con prolunga e terminale con scontro gancio-punzone integrato



8.2 Asta a leva



8.2.1 Aste a leva per legno scostamento 13 mm profondità battuta 24 mm U-8x24x8						No				
argento	destro	2 ganci - punzoni	1.050	8	24	8	2.255	340	5	219417 ¹
		2 scrocchi-ganci	1.050	8	24	8	2.255	340	5	A 219798 ²
		2 scrocchi-ganci K+605	1.050	8	24	8	2.130	340	5	219800 ^{2*}
		2 scrocchi-ganci K+980	1.050	8	24	8	2.400	185	5	219802 ²
		2 scrocchi-punzoni	1.050	8	24	8	2.255	340	5	219423 ³
		2 scrocchi-punzoni K+605	1.050	8	24	8	2.130	340	5	219425 ³
		2 scrocchi-punzoni K+980	1.050	8	24	8	2.400	185	5	219427 ³
	sinistro	2 ganci - punzoni	1.050	8	24	8	2.255	340	5	219418 ¹
		2 scrocchi-ganci	1.050	8	24	8	2.255	340	5	219799 ²
		2 scrocchi-ganci K+605	1.050	8	24	8	2.130	340	5	219801 ^{2*}
		2 scrocchi-ganci K+980	1.050	8	24	8	2.400	185	5	219803 ²
		2 scrocchi-punzoni	1.050	8	24	8	2.255	340	5	219424 ³
		2 scrocchi-punzoni K+605	1.050	8	24	8	2.130	340	5	219426 ^{3*}
		2 scrocchi-punzoni K+980	1.050	8	24	8	2.400	185	5	219428 ³

¹ Viene utilizzato con serratura comando cilindro modulare Z-TS

² Viene utilizzato con serratura autobloccante Z-TA

³ Viene utilizzato con serratura automatica comando cilindro Z-TF



8.2.2 Aste a leva per legno scostamento 13 mm profondità battuta 28 mm U-8x28x8						No				
argento	destro	2 ganci - punzoni	1.050	8	28	8	2.255	340	5	212409 ^{1*}
		2 scrocchi-ganci	1.050	8	28	8	2.255	340	5	A 219032 ²
		2 scrocchi-ganci K+605	1.050	8	28	8	2.130	340	5	219591 ²
		2 scrocchi-ganci K+980	1.050	8	28	8	2.400	185	5	219593 ^{2*}
		2 scrocchi-punzoni	1.050	8	28	8	2.255	340	5	214208 ^{3*}
		2 scrocchi-punzoni K+605	1.050	8	28	8	2.130	340	5	217144 ³
		2 scrocchi-punzoni K+980	1.050	8	28	8	2.400	185	5	214210 ^{3*}
	sinistro	2 ganci - punzoni	1.050	8	28	8	2.255	340	5	212410 ^{1*}
		2 scrocchi-ganci	1.050	8	28	8	2.255	340	5	219033 ²
		2 scrocchi-ganci K+605	1.050	8	28	8	2.130	340	5	219592 ²
		2 scrocchi-ganci K+980	1.050	8	28	8	2.400	185	5	219594 ^{2*}
		2 scrocchi-punzoni	1.050	8	28	8	2.255	340	5	214209 ^{3*}
		2 scrocchi-punzoni K+605	1.050	8	28	8	2.130	340	5	217145 ³
		2 scrocchi-punzoni K+980	1.050	8	28	8	2.400	185	5	214211 ^{3*}

¹ Viene utilizzato con serratura comando cilindro modulare Z-TS

² Viene utilizzato con serratura autobloccante Z-TA

³ Viene utilizzato con serratura automatica comando cilindro Z-TF



8.2.3 Asta a leva scostamento 13 mm U-8x28x8 cava ferramenta contrapposta												No
argento	destro	2 ganci - punzoni	1.050	8	28	8	2.255	340	5	A	213115¹	
		2 scrocchi-ganci	1.050	8	28	8	2.255	340	5	B	219030²	
		2 scrocchi-ganci K+605	1.050	8	28	8	2.130	340	5		219586²	
		2 scrocchi-ganci K+980	1.050	8	28	8	2.400	185	5		219589²	
		2 scrocchi-punzoni	1.050	8	28	8	2.255	340	5		214216³	
		2 scrocchi-punzoni K+605	1.050	8	28	8	2.130	340	5		217154^{3*}	
		2 scrocchi-punzoni K+980	1.050	8	28	8	2.400	185	5		214218^{3*}	
	sinistro	2 ganci - punzoni	1.050	8	28	8	2.255	340	5		213116¹	
		2 scrocchi-ganci	1.050	8	28	8	2.255	340	5		219031²	
		2 scrocchi-ganci K+605	1.050	8	28	8	2.130	340	5		219588²	
		2 scrocchi-ganci K+980	1.050	8	28	8	2.400	185	5		219590²	
		2 scrocchi-punzoni	1.050	8	28	8	2.255	340	5		214217³	
		2 scrocchi-punzoni K+605	1.050	8	28	8	2.130	340	5		217155^{3*}	
		2 scrocchi-punzoni K+980	1.050	8	28	8	2.400	185	5		214219³	

¹ Viene utilizzato con serratura comando cilindro modulare Z-TS

² Viene utilizzato con serratura autobloccante Z-TA

³ Viene utilizzato con serratura automatica comando cilindro Z-TF



8.2.4 Aste a leva 4 funghi HM1050 F16									No
argento	destro	4 funghi	1.050	16	2.150	287	5	A	227136
	sinistro	4 funghi	1.050	16	2.150	287	5		227137

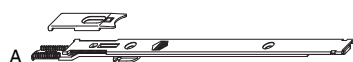

8.2.5 Prolunga ferramenta					No
argento	Prolunga ferramenta non rasabile		250	20	A 10585



8.2.6 Terminale per asta a leva F16 senza scontro integrato						No
argento			16	170	20	A 55049



8.2.7 Collegamento asta dentata				No
Giunzione doppia ferramenta fermo frontali per A-R triangolo argento			50	A 10792*

8.3 Terminale per asta a leva

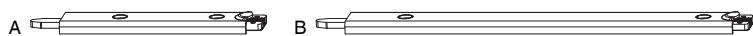

8.3.1 Terminali per legno scostamento 13mm profondità battuta 24 mm U-8x24x8						L		No	
argento	dx / sx	A12 scost. 13 mm	8	24	8	125	10	A	219444
						260	5	B	219445
						415	5		219446

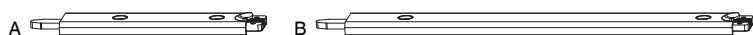

8.3.2 Terminali per legno scostamento 13mm profondità battuta 28 mm U-8x28x8						L		No	
argento	destro	per legno battuta liscia A12	8	28	8	125	5	A	215858*
	sinistro	per legno battuta liscia A12	8	28	8	125	5		215859
	destro	per legno battuta liscia A12	8	28	8	260	5	B	212419
	sinistro	per legno battuta liscia A12	8	28	8	260	5		212420
	destro	per legno battuta liscia A12	8	28	8	415	5	C	212421*
	sinistro	per legno battuta liscia A12	8	28	8	415	5		212422*

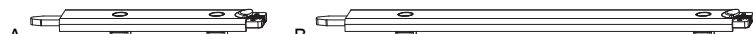

8.3.3 Terminale scostamento 13mm U-8x28x8 per cava ferramenta						L		No	
argento	destro	per cava ferramenta	8	28	8	125	10	A	215862
	sinistro	per cava ferramenta	8	28	8	125	10		215863
	destro	per cava ferramenta	8	28	8	260	5	B	213621
	sinistro	per cava ferramenta	8	28	8	260	5		213622
	destro	per cava ferramenta	8	28	8	415	5	C	213623
	sinistro	per cava ferramenta	8	28	8	415	5		213624

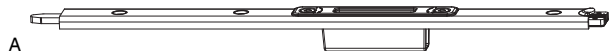

8.3.4 Terminali per legno profondità battuta 24 mm con sconto scrocco-gancio/gancio-punzone integrato U-8x24x8						L		No	
argento	destro	A12 scost. 13 mm	8	24	8	355	5	A	219438*
	sinistro	A12 scost. 13 mm	8	24	8	355	5		219439*
	destro	A12 scost. 13 mm	8	24	8	565	5	B	219440*
	sinistro	A12 scost. 13 mm	8	24	8	565	5		219441*



8.3.5 Terminali per legno profondità battuta 28 mm con scontro scrocco-gancio/gancio-punzone integrato U-8x28x8					L		No
argento	destro	8	28	8	355	5	A 216254*
	sinistro	8	28	8	355	5	216255*

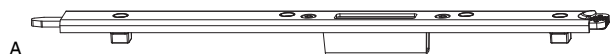





8.3.6 Terminali con scontro scrocco-gancio/gancio-punzone integrato U-8x28x8 per cava ferramenta contrapposta					L		No	
argento	destro	cava ferramenta contrapposta	8	28	8	355	5	A 216294*
	sinistro	cava ferramenta contrapposta	8	28	8	355	5	216295*

8.4 Prolunghe per asta a leva



8.4.1 Prolunghe per asta a leva scostamento 13mm scontro scrocco-gancio/gancio-punzone integrato U-8x24x8					L		No		
argento	destro	A12 scost. 13 mm	8	24	8	590	5	A	219442
	sinistro	A12 scost. 13 mm	8	24	8	590	5		219443



8.4.2 Prolunghe per asta a leva scostamento 13mm scontro scrocco-gancio/gancio-punzone integrato U-8x28x8					L		No		
argento	destro	legno A12, PB 28	8	28	8	590	5	A	216258*
	sinistro	legno A12, PB 28	8	28	8	590	5		216259*



8.4.3 Prolunghe per asta a leva scostamento 13mm scontro scrocco-gancio/gancio-punzone integrato U-8x28x8 cava ferramenta contrapposta					L		No		
argento	destro	cava ferramenta contrapposta	8	28	8	590	5	A	216298*
	sinistro	cava ferramenta contrapposta	8	28	8	590	5		216299*

MACO
PROTECT



Asta a leva

MACO
PROTECT



9 Catenacci

9.1	Catenaccio per portoncino	86
9.1.1	Catenaccio per portoncino A4	86
9.1.2	Catenaccio per portoncino A12	87
9.1.3	Catenaccio per portoncino per cava ferramenta	88
9.1.4	Catenaccio per portoncino larghezza 18 mm	88
9.2	Catenaccio porta interna	89
9.2.1	Catenaccio porta interna A4	89

9 Catenacci

9.1 Catenaccio per portoncino

9.1.1 Catenaccio per portoncino A4

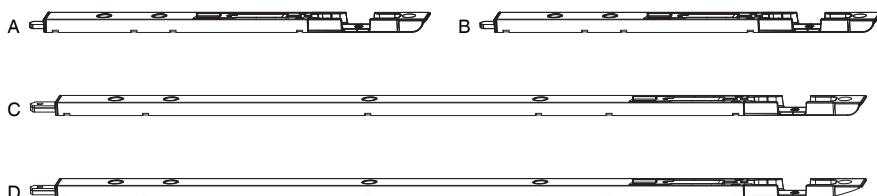

9.1.1.1 Catenaccio per portoncino A4 scost. 9 mm

					L		No		
argento	Aria 4	R8	11	8	255	20	A	58464	
					540	20		58468	
		18	8	255	20	B	208998		
				540	20		208999		
			10	540	20	C	55985		
				255	20		55989		
		inferiore sinistro	R8	18	7	255	20		59424
		inferiore destro	R8	18	7	255	20		59425
		R8	18	10	185	20		457573	
					540	20	D	58463*	
255	20			58467*					
	10		255	20		59422			
			540	20		59423			



9.1.1.2 Catenaccio per portoncino A4 scost. 13 mm U-6x24x6

				L		No		
argento	A4 sc.13	superiore destro	18	8	560	20	224124*	
		superiore sinistro	18	8	560	20	224125*	
		inferiore destro	18	8	275	20	224126*	
		inferiore sinistro	18	8	275	20	224127*	
		sinistro	20	10	120	20	213834*	
		destro	20	10	120	20	A	213833*
		superiore destro	20	10	560	20	B	219513*
		superiore sinistro	20	10	560	20		219514*
		inferiore destro	20	10	275	20		219515*
		inferiore sinistro	20	10	275	20		219516*
		superiore destro	20	10	275	20		219517*
		superiore sinistro	20	10	275	20		219518*

9.1.2 Catenaccio per portoncino A12



9.1.2.1 Catenaccio per portoncino A12 scost. 9 mm					L			No
argento	Aria 4	R8	11	8	255	20		58464 ¹
					540	20		58468 ¹
			18	8	255	20		208998 ¹
					540	20		208999 ¹
					10	540	20	
	battuta liscia	18	10	200	20	A	210876	
				255	20	B	221097	

¹ Deve essere utilizzato con terminale 43718!

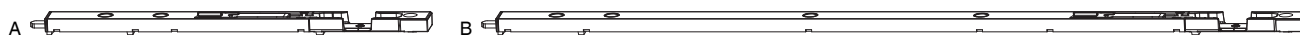

9.1.2.2 Catenaccio per portoncino A12 canalino euro 6/8/4				L			No
argento	canalino Euro 6/8/4 sinistro	11	8	255	20		58609
				540	20		59426*
	destro	11	8	255	20	A	58608
				540	20	B	59427*





9.1.2.3 Catenaccio per portoncino A12 canalino euro 7/8/4				L			No
argento	canalino Euro 7/8/4 sinistro	11	8	255	20		59428
				540	20		59430
	destro	11	8	255	20	A	59429
				540	20		59431*
	sinistro	18	10	255	20		58575
	destro	18	10	255	20	B	58574





9.1.2.4 Catenaccio per portoncino A12 scost. 13 mm U-6x24x6				L			No	
argento	per A12 scostamento 13	destro	20	10	120	20	A	213831
					120	20		213832
		superiore destro	20	10	560	20		219519
					560	20		219520*
		inferiore destro	20	10	275	20		219521*
		inferiore sinistro	20	10	275	20		219522*
		superiore destro	20	10	275	20		219523*
		superiore sinistro	20	10	275	20		219524*

9.1.3 Catenaccio per portoncino per cava ferramenta







9.1.3.1 Catenaccio per portoncino U-6x24x6					L		No
argento	per cava ferramenta guarnizione centrale MD	sinistro	20	10	120	20	213830
		destro	20	10	120	20	A 213829



9.1.3.2 Catenaccio per portoncino U-6x32x6					L		No
argento	per cava ferramenta	destro	20	10	130	20	A 213825
		sinistro	20	10	130	20	213826





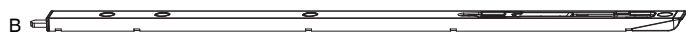
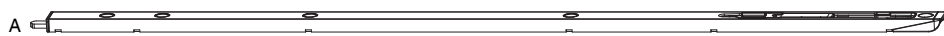

9.1.4 Catenaccio per portoncino larghezza 18 mm						L		No
argento	Aria 4	R8	11	8	255	20	58464¹	
					540	20	58468¹	
			18	8	255	20	A 208998¹	
					540	20	208999¹	
			10	540	20	55985¹		
				255	20	55989¹		

¹ Deve essere utilizzato con spessore per cava ferramenta!

9.2 Catenaccio porta interna



9.2.1 Catenaccio porta interna A4

					L			Nº
argento	Aria 4	R8	12	8	600	20	A	58465
					540	20		209000
					255	20		57915
					425	20	B	57916
					255	20		58029
		R90	12	8	255	20		58030
					425	20		58030
					600	20		58469*

MACO
PROTECT



Catenacci

MACO
PROTECT

10 Accessori

10.1	Terminale per serratura comando cilindro e maniglia	92
10.1.1	Terminale	92
10.1.2	Terminale ad inversione	93
10.2	Accessori per serratura autobloccante A-TS	94
10.2.1	Prolunga per serratura	94
10.2.2	Giunzione accorciamento per serratura	94
10.2.3	Prolunga con punto di chiusura	94
10.2.4	Motore per serratura autobloccante	94
10.2.5	openDoor	95
10.2.6	Cavi e accessori per serratura motorizzata aria 4 e aria 12	96
10.2.7	Magnete di test per serratura autobloccante	96
10.2.8	Alimentatori - trasformatori	96
10.2.9	Blocco meccanismo funzione giorno	97
10.3	Accessori per serratura modulare	98
10.3.1	Prolunga per serratura	98
10.3.2	Giunzione accorciamento serratura	98
10.3.3	Prolunga con punto di chiusura	98
10.3.4	Componente frontale con contatto magnetico	98
10.3.5	Componente frontale con gancio-punzone	99
10.3.6	Componente frontale con delimitatore d'apertura	99
10.4	Accessori per serratura portafinestra Multi Matic	100
10.4.1	Prolunga frontale per serratura portafinestra Multi Matic	100
10.4.2	Movimento angolare per serratura portafinestra	100
10.4.3	Terminale superiore con fungo	100
10.4.4	Terminale superiore con fungo e puntale	100
10.4.5	Terminale inferiore senza nottolino con puntale	100
10.5	Scrocco a rullo per serrature comando cilindro	101
10.6	Scrocco smussato per serrature comando cilindro	101
10.7	Scrocco smussato per serratura automatica	101
10.8	Spessori catenaccio	101
10.9	Terminali	101
10.10	Coprifresate	102
10.11	Coperture	102
10.12	Frontali di copertura	102
10.13	Boccola a pavimento	102
10.14	Chiave per prova serratura	102
10.15	Antistrappo	103
10.16	Clip per scrocco	103
10.17	Apriporta elettrico	103

10 Accessori

10.1 Terminale per serratura comando cilindro e maniglia

10.1.1 Terminale

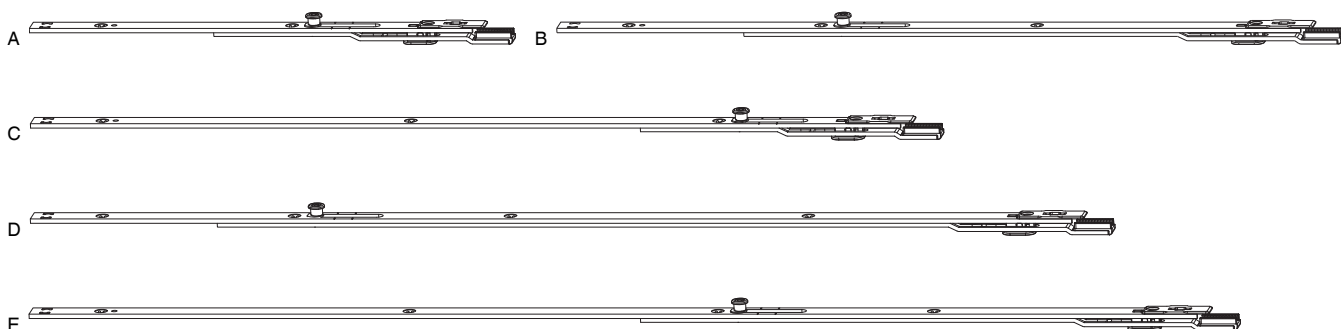

10.1.1.1 Terminale senza puntale					L			No
argento	1.900 - 2.100	16	255	1	300	10	A	57824
		20	255	1	300	10		11243*
	2.100 - 2.300	16	255	1	500	10	B	55993
		20	255	1	500	10		11244*
	2.185 - 2.385	16	540	1	585	10	C	57825
		20	540	1	585	10		101489*
	2.300 - 2.500	16	255	1	700	10	D	57826
		20	255	1	700	10		101490*
	2.385 - 2.585	16	540	1	785	10	E	57827

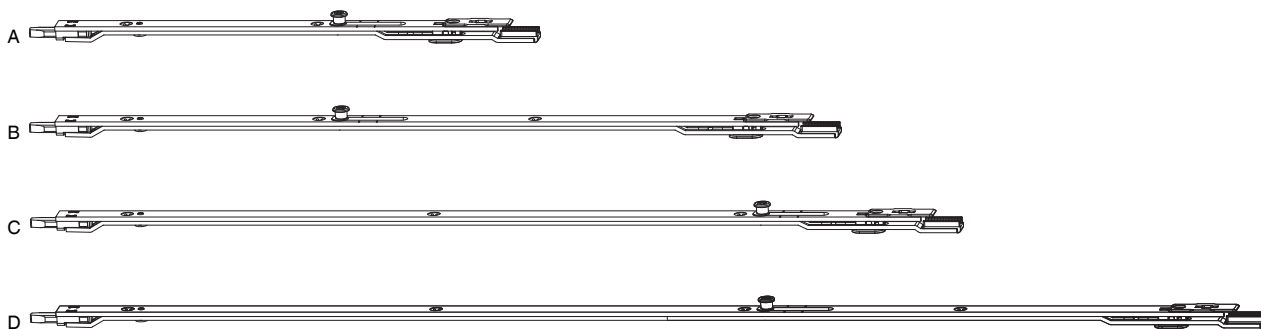

10.1.1.2 Terminale con puntale						L			No
argento	1.900 - 2.100	16	255	9	1	300	10	A	58107
		20	255	9	1	300	10		101483*
	2.100 - 2.300	16	255	9	1	500	10	B	55992*
	2.185 - 2.385	16	540	9	1	585	10	C	58458
	2.385 - 2.585	16	540	9	1	785	10	D	58333*

10.1.2 Terminale ad inversione

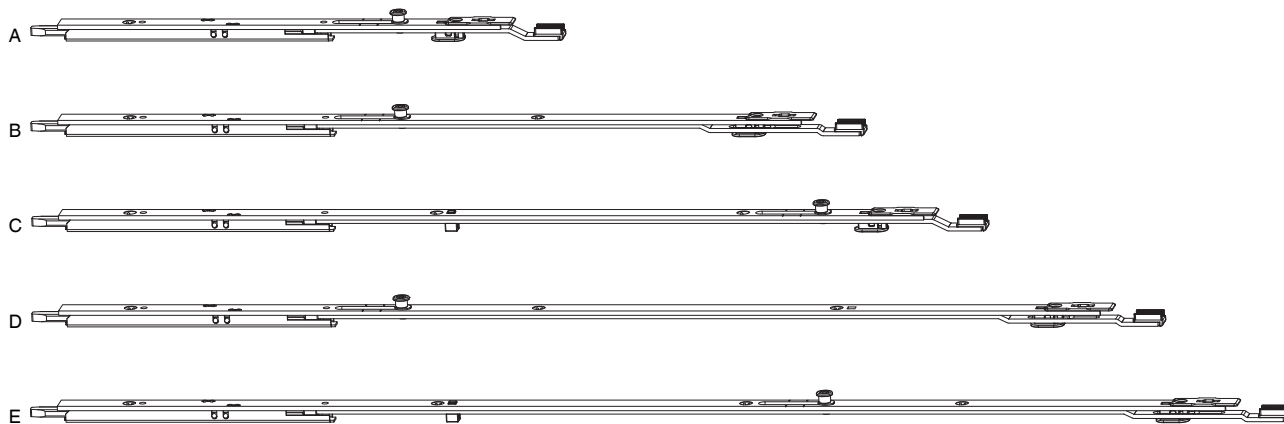

10.1.2.1 Terminale ad inversione con puntale						L		No
argento	1.900 - 2.100	16	255	9	1	300	10	A 200983
		20	255		1	300	10	101484*
	2.100 - 2.300	16	255	9	1	500	10	B 200984
		20	255		1	500	10	101485
	2.185 - 2.385	16	540	9	1	585	10	C 200985
		20	540	9	1	585	10	101486*
	2.300 - 2.500	16	255	9	1	700	10	D 200986
		20	255	9	1	700	10	101487*
	2.385 - 2.585	16	540	9	1	785	10	E 200987
		20	540	9	1	785	10	101488*

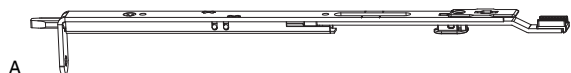

10.1.2.2 Terminale ad inversione con puntale e angolo d'appoggio					L		No
argento	1.900 - 2.100	16	255	9	300	10	A 58335*
		20	255	9	300	10	101073

10.2 Accessori per serratura autobloccante A-TS

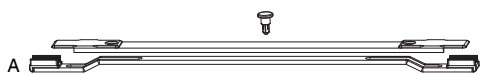

10.2.1 Prolunga per serratura			L		No
Prolunga per serratura autobloccante argento	F	16	250	10	A 104785*
		20	250	10	104786*
		24 / 16	250	10	104788*
	U	24	250	10	104789

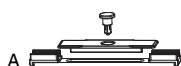

10.2.2 Giunzione accorciamento per serratura			L		No
Giunzione accorciamento per serratura autobloccante argento	F	16	50	10	A 104790*
		20	50	10	104791*
		24	50	10	104792*
		24 / 16	50	10	104793*
	U	24	50	10	104794

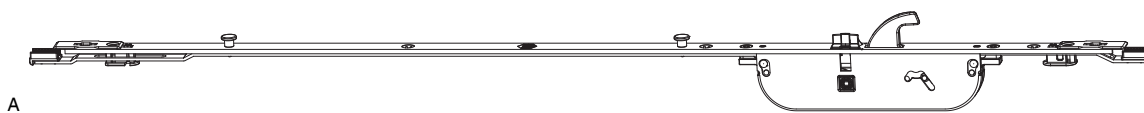

10.2.3 Prolunga con punto di chiusura			L		No
Prolunga con scrocco-gancio per serratura autobloccante argento	F	16	705	5	A 227051*
		20	705	5	227052*
		24	705	5	227053*
		24 / 16	705	5	227054*
	U	24	705	5	227055*

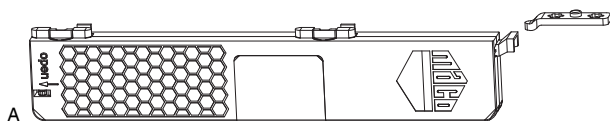

10.2.4 Motore per serratura autobloccante			No
Motore per serratura autobloccante		1	A 104130

10.2.5 openDoor

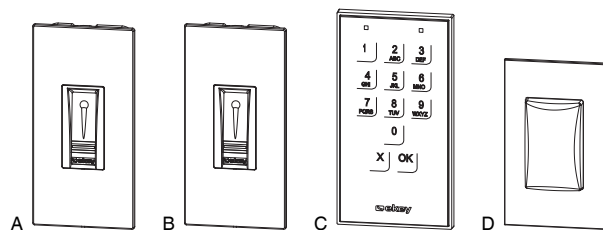

10.2.5.1 Sistemi di accesso



Nº

Lettore d'impronta	1	A	476513
Lettore d'impronta BT	1	B	476514*
Tastierino numerico	1	C	476515*
Lettore d'impronta BT per maniglioni	1		478065*
openDoor Transponder Plus E	1	D	466699*

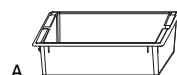

A

10.2.5.2 Scatola incasso per sistemi di accesso



Nº

Scatola incasso FS IN per sistema d'accesso ekey	5	A	478181*
--	---	---	---------

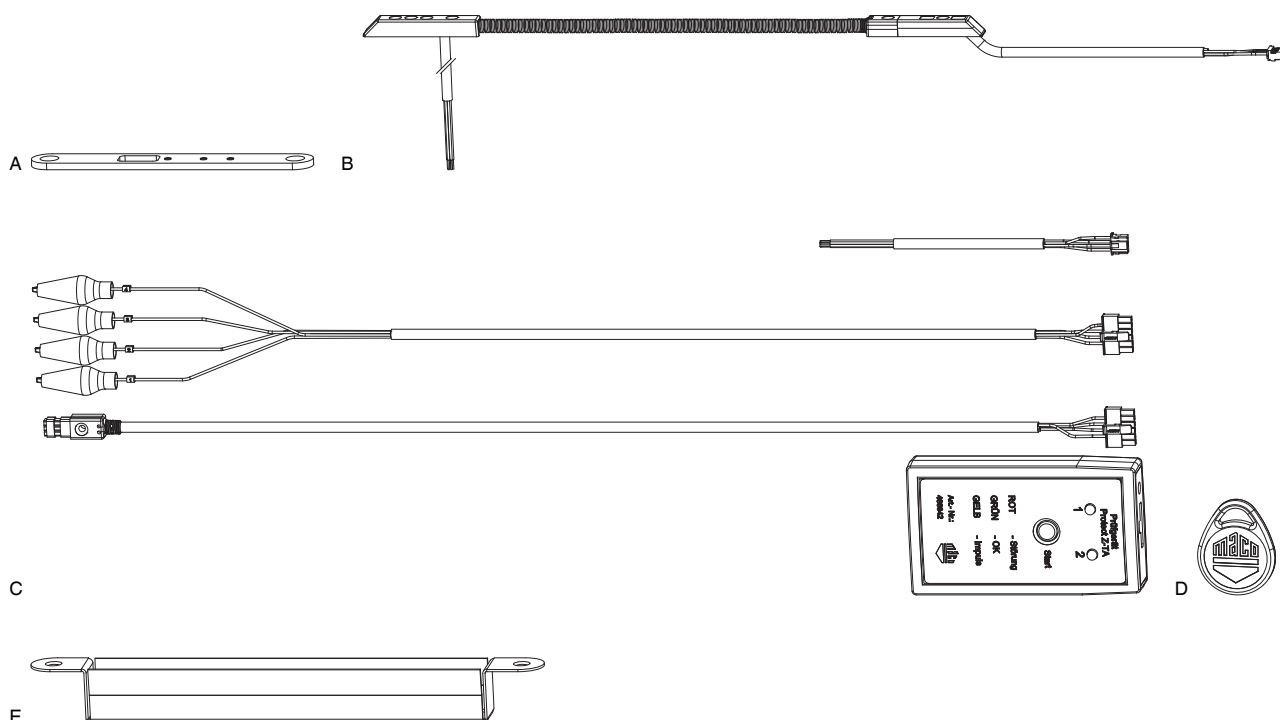

10.2.6 Cavi e accessori per serratura motorizzata aria 4 e aria 12		No
Cavo con spina 10 m	1	466835
Cavo con spina 150 mm	1	466836
Copertura passacavo F-16 INOX	1	A 363473
Copertura passacavo F-20	1	466838
Passacavo con spina 2,5/10 m	1	466834
Passacavo con spina 2,5/6 m	1	B 466833
Tester	1	C 466842*
Transponder 125 kHz per Open Door	1	D 458274*
Vaschetta per passacavo A4	1	E 466837



10.2.7 Magnete di test per serratura autobloccante		No
Magnete di prova per serratura autobloccante	20	A 227538*

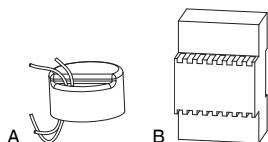

10.2.8 Alimentatori - trasformatori		No
Trasformatore per scatola di derivazione 12V	1	A 367702
Trasformatore per montaggio su binario DIN	1	B 367701*

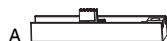

10.2.9 Blocco meccanismo funzione giorno



Nº

Blocco meccanismo funzione giorno per serratura autobloccante

10

A

228432*

10.3 Accessori per serratura modulare



10.3.1 Prolunga per serratura

			L			Nº
Prolunga per serratura argento	F	16	250	10	A	102219
		20	250	10		102555
		24	250	10		102745
		24/16	250	10		102929*
	U	24	250	10		103059*



10.3.2 Giunzione accorciamento serratura

			L			Nº
Giunzione accorciamento serratura argento	F	16	50	10	A	102556
		20	50	10		102557
		24	50	10		103062*
		24/16	50	10		102930*
	U	24	50	10		103058*



A



B

10.3.3 Prolunga con punto di chiusura

			L			Nº
Prolunga con gancio-punzone argento	F	16	705	5	A	212643
		20	705	5		212758*
		24	705	5		212762*
		24/16	705	5		213961*
	U	24	705	5		215376*
Prolunga con punzone argento	F	16	705	5	B	215098*
		20	705	5		215099*
		24/16	705	5		215101*

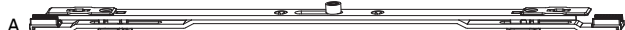

10.3.4 Componente frontale con contatto magnetico

			L			Nº
Componente frontale con contatto magnetico argento	F	16	350	5	A	212646*
		20	350	5		212761*
		24	350	5		212765*
		24/16	350	5		213964*
		U	24	350	5	

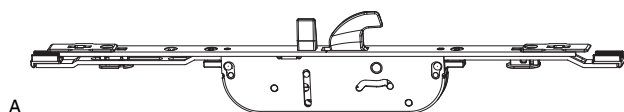

A

10.3.5 Componente frontale con gancio-punzone

Componente frontale con gancio-punzone argento

		L		No
F	16	350	5	A 212644*
	20	350	5	212759*
	24	350	5	212763*
	24 /16	350	5	213962*
U	24	350	5	215377*

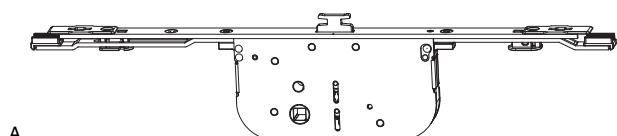

A

10.3.6 Componente frontale con delimitatore d'apertura

Componente frontale con delimitatore d'apertura argento

			L		No
F	16	E 35	350	5	213046*
		E 45	350	5	213048*
		E 50	350	5	213049*
		E 55	350	5	A 213050*
		E 65	350	5	213051*
20		E 35	350	5	213054*
		E 40	350	5	213055*
		E 45	350	5	213056
		E 50	350	5	213057*
		E 65	350	5	213059*
24 /16		E 35	350	5	214030*
		E 45	350	5	214032*
		E 50	350	5	214033*
		E 65	350	5	214035*
U	24	E 35	350	5	215381*
		E 45	350	5	215382*

10.4 Accessori per serratura portafinestra Multi Matic



10.4.1 Prolunga frontale per serratura portafinestra Multi Matic

argento



L



Nº

1	1.701 - 1.950	497	10	A	203697
	1.951 - 2.200	747	10		203698
2	2.201 - 2.450	997	10		203699



10.4.2 Movimento angolare per serratura portafinestra

argento

con 1 fungo



Nº

320 - 1.800	360 - 2.800	50	A	222201
-------------	-------------	----	---	--------



10.4.3 Terminale superiore con fungo

argento



L



Nº

1	113,5	20	A	212687
---	-------	----	---	--------



10.4.4 Terminale superiore con fungo e puntale

argento



L



Nº

431 - 2.450	80	100	A	214013
		100	B	214014
		100	C	218977
		100	D	218978*
	113,5	20	E	208432
		20	F	214016



10.4.5 Terminale inferiore senza nottolino con puntale

argento



L



Nº

500 - 2.350	16	170	170	20	A	225092
-------------	----	-----	-----	----	---	--------

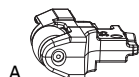

10.5 Scrocco a rullo per serrature comando cilindro



Nº

Scrocco a rullo serratura comando cilindro E 35	10	A	203784
Scrocco a rullo serratura comando cilindro E 40	10		203785
Scrocco a rullo serratura comando cilindro E 45	10		203786
Scrocco a rullo serratura comando cilindro E 50	10		203787
Scrocco a rullo serratura comando cilindro E 55	10		203788
Scrocco a rullo serratura comando cilindro E 65	10		203790
Scrocco a rullo serratura comando cilindro E 70	10		203791*
Scrocco a rullo serratura comando cilindro E 80	10		203792*



10.6 Scrocco smussato per serrature comando cilindro



Nº

Scrocco ridotto serratura comando cilindro E 35	10	A	101555*
Scrocco ridotto serratura comando cilindro E 40	10		101556*
Scrocco ridotto serratura comando cilindro E 45	10		101553
Scrocco ridotto serratura comando cilindro E 50	10		101557*
Scrocco ridotto serratura comando cilindro E 55	10		101477*
Scrocco ridotto serratura comando cilindro E 65	10		101558*
Scrocco ridotto serratura comando cilindro E 70	10		101559*
Scrocco ridotto serratura comando cilindro E 80	10		101560*



10.7 Scrocco smussato per serratura automatica



Nº

Scrocco smussato per serratura automatica	10	A	102293*
---	----	---	---------



10.8 Spessori catenaccio



Nº

Spessore catenaccio portoncino L=200 per serratura automatica	20		360159
Spessore per catenaccio per cava ferramenta xmm S=mm argento	50	A	44253
Inserto per catenaccio portafinestra A12 canalino Euro	100	B	44268
Spessore catenaccio portoncino dx cava ferramenta pressione -1mm	50		44372
Spessore catenaccio portoncino sx cava ferramenta pressione -1mm	50		44373
Spessore per catenaccio portoncino L=255 A4 scostamento13 grigio	100		460342



10.9 Terminali



Nº

Inserto per scontro e catenaccio A4 su A12 battuta liscia/18	100	A	43718
Terminale in plastica per scontro ad angolo 24x8 A12 battuta liscia/24 24xmm S=mm nero	100	B	362920
Terminale in plastica per scontro scrocco battuta liscia PB 18 sc.9 xmm S=mm	100	C	360074
Terminale in plastica per scontro battuta liscia PB 20 sc.9 S=0mm argento	100	D	354358
Terminale in plastica per scontro destro canalino Euro xmm S=mm argento	100	E	44205*
Terminale in plastica per scontro sinistro canalino Euro xmm S=mm argento	100	F	44206*



10.10 Coprifresate



Nº

Coprifresata Scontro gancio-punzone legno lungo dx+sx nero	50	A	358024
Coprifresata serratura per scontro scrocco-mandata nero	50	B	360397
Coprifresata scontro scrocco-punzone per apriporta elettrico -30,7x nero	100	C	364326
Coprifresata serratura per scontro scrocco-mandata per profili in legno argento	50	D	43524



10.11 Coperture



Nº

Copertura per avvitamento inclinato nero	100	A	362704
Copertura Scontro scrocco-punzone nero	100	B	363959



10.12 Frontali di copertura



Nº

Prolunga per asta scontri U-6/24/6 argento	5	A	102852
Frontale di copertura F-1.400x20 argento	20	B	364770*
Frontale di copertura F-1.400x24/16 argento	20		364771*
Frontale di copertura U-1.000x24 argento	5		103001
Frontale di copertura 1.400 argento	10		94019*



10.13 Boccola a pavimento



Nº

Boccola ad incasso D=14 H=22 per puntale 8x4 argento	100	A	94219
Boccola a pavimento	1		453541

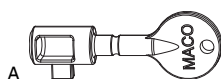

10.14 Chiave per prova serratura



Nº

Chiave per prova serratura	20	A	40720
----------------------------	----	---	--------------

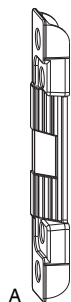

A

10.15 Antistrappo



Nº

argento	Antistrappo parte anta	20		217584 ^{1,2,3}
	Antistrappo parte telaio A4 scost. 13 mm	20	A	367738 ^{4,5*}
	Antistrappo parte telaio legno PB18/scost.9 e PB 22/scost.13	20		367505
	Antistrappo parte telaio canalino Euro	20		367722
	Antistrappo parte telaio A4 scost. 9 mm	20		368014 ^{5,6}

¹ L'anta deve avere la cava ferramenta nel campo della parte anta

² Per profili PVC e alu-legno vedere schede di profilo

³ Da utilizzare per la sicurezza di base MACO B e D

⁴ Profondità fresata 22 mm

⁵ Lunghezza fresata 120 mm

⁶ Profondità fresata 18 mm



A

10.16 Clip per scrocco



Nº

Clip per scrocco		50	A	43586
Clip per scrocco smussato		50		362906*

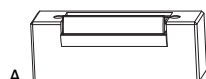

A

10.17 Apriporta elettrico



Nº

Apriporta elettrico largo con antiripetitore con sblocco meccanico 6-24 V		1	A	456229 ¹
Apriporta elettrico largo senza antiripetitore con sblocco meccanico 6-24 V		1		456348 ^{1*}
Apriporta elettrico stretto senza antiripetitore con sblocco meccanico 6-24 V		1		456351 ^{1*}
Apriporta elettrico stretto con antiripetitore con sblocco meccanico 6-24 V		1		456353 ¹
Apriporta elettrico 128E.15SET--A71 con antiripetitore con sblocco meccanico 10-24V		1		463097 ¹
Apriporta elettrico 118E.15SET--A71 senza antiripetitore con sblocco meccanico 10-24V		1		463098 ¹

¹ Con apriporta elettrico ordinare anche il clip per scrocco

MACO
PROTECT



Accessori

MACO
PROTECT



11 Dime

11.1 Dime per scontri	106
11.1.1 Dime per scontri A4	106
11.1.2 Dime pezzi sciolti	106
11.1.3 Dime per scontri A12	106
11.1.4 Dima foro cilindro e maniglia	107
11.1.5 Dima catenaccio	107

11 Dime

11.1 Dime per scontri

11.1.1 Dime per scontri A4



11.1.1.1 Dime per 1 e 2 ante comando cilindro A4



No

Asta forata per dima fresa per scontro serratura 1+2 ante per aria 4mm	1		101292*
Asta + morsetti per serratura comando cilindro Scontri gancio-punzone	1	A	463269*
Asta + morsetti per serratura comando cilindro per 2 funghi e 2 ganci-punzoni	1		463268*

11.1.2 Dime pezzi sciolti

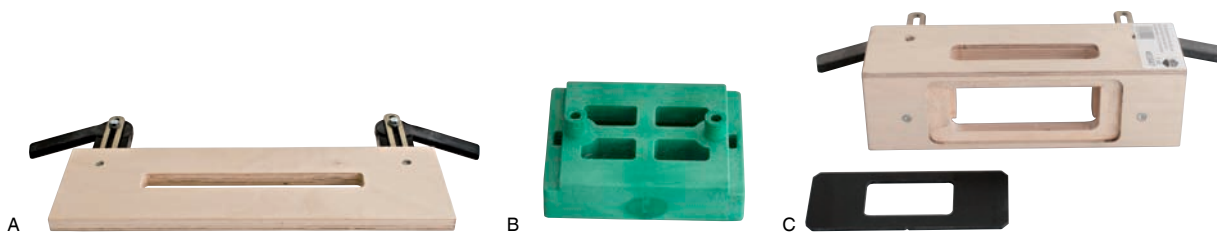

11.1.2.1 Dime pezzi sciolti serratura A4



No

Dima per scontro scrocco-mandata A4 serratura autobloccante 220 x 8mm	1	A	467734*
Dima per serratura comando maniglia e cilindro scontro scrocco mandata per aria 4mm	1		X801920
Dima fresa serratura comando cilindro per scontro fungo	1		X804521
Dima fresa fresata L=120 A4 scost.9 mm	1		X804522
Spessore per dima 2ante	1	B	X804540
Dima scontro punzone-gancio dx+sx per A4 fresatea L=180	1		461742*
Dima per scontro scrocco ad angolo 8x24 dx+sx per A4 scostamento 13 L=24 argento	1	C	463947*
Dima per scontro gancio-punzone ad angolo 8x24 dx+sx per A4 scostamento 13 L=24 argento	1		463946*

11.1.3 Dime per scontri A12



11.1.3.1 Dime per serratura comando cilindro A12 per scontri fungo L=48mm



No

Dima completa con guidascontro serratura comando cilindro a 4 funghi 1+2 ante per legno e PVC	1	A	203797*
---	---	---	---------

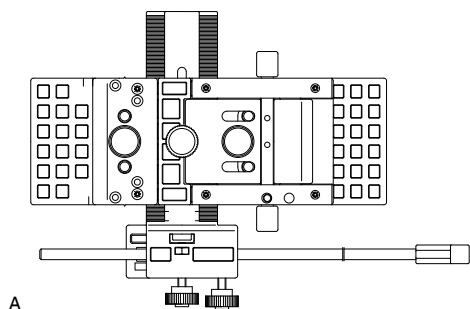

A

11.1.4 Dima foro cilindro e maniglia



No

Dima forature per scatola serratura

1

A

28603*



A

11.1.5 Dima catenaccio



No

Dima per catenaccio L=255-425-540-600 mm

1

A

X992204*



12 Indice articoli

N ^o	Gruppo	 € (/100 = 100 pz.)	Pagina
1			
101073		10	93
101292	IT-S-1	1	106
101477	IT-C-7-8	10	101
101483	IT-C-7-1	10	92
101484	IT-C-7-1	10	93
101485		10	93
101486	IT-C-7-1	10	93
101487	IT-C-7-1	10	93
101488	IT-C-7-1	10	93
101489	IT-C-7-1	10	92
101490	IT-C-7-1	10	92
101553	IT-C-7-8	10	101
101555	IT-C-7-8	10	101
101556	IT-C-7-8	10	101
101557	IT-C-7-8	10	101
101558	IT-C-7-8	10	101
101559	IT-C-7-8	10	101
101560	IT-C-7-8	10	101
102219	IT-C-7-1	10	98
102293	IT-C-7-8	10	101
102555	IT-C-7-1	10	98
102556	IT-C-7-1	10	98
102557	IT-C-7-1	10	98
102745	IT-C-7-1	10	98
102850	IT-C-7-4	5	66
102851	IT-C-7-4	5	66
102852	IT-C-7-1	5	102
102929	IT-C-7-1	10	98
102930	IT-C-7-1	10	98
102998	IT-C-7-3	20	73
103001	IT-C-7-7	5	102
103058	IT-C-7-1	10	98
103059	IT-C-7-1	10	98
103062	IT-C-7-1	10	98
103413	IT-C-7-3	20	65
104130	IT-C-B-3	1	94
104785	IT-C-7-1	10	94
104786	IT-C-7-1	10	94
104788	IT-C-7-1	10	94
104789	IT-C-7-1	10	94
104790	IT-C-7-1	10	94
104791	IT-C-7-1	10	94
104792	IT-C-7-1	10	94
104793	IT-C-7-1	10	94
104794	IT-C-7-1	10	94
10585	IT-A-1-B-3	20	80
10792	IT-A-1-B-9	50	80
11243	IT-C-7-1	10	92
11244	IT-C-7-1	10	92
2			
200983	IT-C-7-1	10	93
200984	IT-C-7-1	10	93
200985	IT-C-7-1	10	93
200986	IT-C-7-1	10	93
200987	IT-C-7-1	10	93
203329	IT-A-1-9-4	100	63
203502	IT-C-7-2	20	50
203503	IT-C-7-2	20	50
203697	IT-C-7-1	10	48,100
203698	IT-C-7-1	10	48,100
203699	IT-C-7-1	10	48,100
203784	IT-C-7-8	10	101
203785	IT-C-7-8	10	101
203786	IT-C-7-8	10	101
203787	IT-C-7-8	10	101
203788	IT-C-7-8	10	101
203790	IT-C-7-8	10	101
203791	IT-C-7-8	10	101

N ^o	Gruppo	 € (/100 = 100 pz.)	Pagina
203792	IT-C-7-8	10	101
203797	IT-S-1	1	106
203834	IT-C-5	5	47
203835	IT-C-5	5	47
203836	IT-C-5	5	47
203837	IT-C-5	5	47
203838	IT-C-5	5	47
203839	IT-C-5	5	47
207861	IT-C-7-3	20	53,60
207862	IT-C-7-3	20	51,58
208432	IT-A-7-2-3-4	20	48,100
208468	IT-C-7-4	5	73
208469	IT-C-7-4	5	73
208470	IT-C-7-4	5	73
208471	IT-C-7-4	5	73
208998	IT-C-7-5	20	86,87,88
208999	IT-C-7-5	20	86,87,88
209000	IT-T-1	20	89
209104	IT-C-7-2	20	64
209105	IT-C-7-2	20	64
209338	IT-A-1-9-4	100	56
209347	IT-C-7-3	50	62
209809	IT-C-7-2	50	61
209810	IT-C-7-2	50	61
209907	IT-C-7-2	50	55
209908	IT-C-7-2	50	55
209909	IT-C-7-3	20	55
209911	IT-C-7-3	20	56
209912	IT-C-7-3	20	56
209979	IT-C-7-3	20	65
210016	IT-C-7-2	20	61
210017	IT-C-7-2	20	61
210501	IT-C-7-3	20	51,58
210502	IT-C-7-3	20	54,60
210779	IT-C-7-3	20	61
210781	IT-C-7-3	20	62
210782	IT-C-7-3	20	62
210813	IT-C-7-2	20	57
210814	IT-C-7-2	20	57
210876	IT-C-7-5	20	87
211369	IT-A-1-9-4	100	63
211544	IT-C-7-3	20	64
211597	IT-C-7-3	20	56
211598	IT-C-7-3	20	62
212282	IT-C-7-2	20	71
212283	IT-C-7-2	20	71
212371	IT-C-7-3	50	74
212409	IT-C-7-4	5	79
212410	IT-C-7-4	5	79
212419	IT-C-7-4	5	81
212420	IT-C-7-4	5	81
212421	IT-C-7-4	5	81
212422	IT-C-7-4	5	81
212474	IT-A-1-9-4	100	63
212643	IT-C-7-1	5	98
212644	IT-C-7-1	5	99
212646	IT-C-7-1	5	98
212647	IT-C-7-3	20	71
212687	IT-A-6-2-9	20	48,100
212758	IT-C-7-1	5	98
212759	IT-C-7-1	5	99
212761	IT-C-7-1	5	98
212762	IT-C-7-1	5	98
212763	IT-C-7-1	5	99
212765	IT-C-7-1	5	98
212820	IT-C-7-2	50	74
212936	IT-C-7-3	20	52
212937	IT-C-7-3	20	52
212939	IT-C-7-3	20	54
212940	IT-C-7-3	20	59

N ^o	Gruppo		€ (/100 = 100 pz.)	Pagina
212941	IT-C-7-3	20		59
213046	IT-C-7-1	5		99
213048	IT-C-7-1	5		99
213049	IT-C-7-1	5		99
213050	IT-C-7-1	5		99
213051	IT-C-7-1	5		99
213054	IT-C-7-1	5		99
213055	IT-C-7-1	5		99
213056	IT-C-7-1	5		99
213057	IT-C-7-1	5		99
213059	IT-C-7-1	5		99
213115	IT-C-7-4	5		80
213116	IT-C-7-4	5		80
213180	IT-C-7-3	20		73
213240	IT-C-7-2	20		73
213241	IT-C-7-2	20		73
213325	IT-C-7-3	20		58
213621	IT-C-7-4	5		81
213622	IT-C-7-4	5		81
213623	IT-C-7-4	5		81
213624	IT-C-7-4	5		81
213825	IT-C-7-5	20		88
213826	IT-C-7-5	20		88
213829	IT-C-7-5	20		88
213830	IT-C-7-5	20		88
213831	IT-C-7-5	20		87
213832	IT-C-7-5	20		87
213833	IT-C-7-5	20		86
213834	IT-C-7-5	20		86
213961	IT-C-7-1	5		98
213962	IT-C-7-1	5		99
213964	IT-C-7-1	5		98
214013	IT-A-7-2-3-4	100		48,100
214014	IT-A-7-2-3-4	100		48,100
214016	IT-A-6-2-9	20		48,100
214030	IT-C-7-1	5		99
214032	IT-C-7-1	5		99
214033	IT-C-7-1	5		99
214035	IT-C-7-1	5		99
214190	IT-C-7-4	5		66
214191	IT-C-7-4	5		66
214208	IT-C-7-4	5		79
214209	IT-C-7-4	5		79
214210	IT-C-7-4	5		79
214211	IT-C-7-4	5		79
214216	IT-C-7-4	5		80
214217	IT-C-7-4	5		80
214218	IT-C-7-4	5		80
214219	IT-C-7-4	5		80
214380	IT-C-7-3	20		65
214407	IT-C-7-2	20		72
214408	IT-C-7-2	20		72
214409	IT-C-7-3	20		72
214455	IT-C-7-2	20		55,61
214456	IT-C-7-2	20		55,61
214457	IT-C-7-3	20		56,62
214458	IT-C-7-3	20		56,62
214459	IT-C-7-3	20		56,62
214466	IT-C-7-4	5		71
214467	IT-C-7-4	5		71
214965	IT-C-7-3	20		58
214968	IT-C-7-3	20		51
215098	IT-C-7-1	5		98
215099	IT-C-7-1	5		98
215101	IT-C-7-1	5		98
215197	IT-C-7-2	20		64
215201	IT-C-7-2	20		64
215231	IT-C-7-4	5		71
215232	IT-C-7-4	5		71
215233	IT-C-7-4	5		71
215234		5		71
215235	IT-C-7-4	5		71
215236	IT-C-7-4	5		71
215376	IT-C-7-1	5		98

N ^o	Gruppo		€ (/100 = 100 pz.)	Pagina
215377	IT-C-7-1	5		99
215380	IT-C-7-1	5		98
215381	IT-C-7-1	5		99
215382	IT-C-7-1	5		99
215424	IT-C-7-3	20		65
215425	IT-C-7-3	20		65
215497	IT-C-7-3	20		65
215785	IT-C-7-3	20		74
215858	IT-C-7-4	5		81
215859	IT-C-7-4	5		81
215862	IT-C-7-4	10		81
215863	IT-C-7-4	10		81
215907	IT-C-7-4	5		66
215908	IT-C-7-4	5		66
215909	IT-C-7-4	5		66
215910	IT-C-7-4	5		66
215911	IT-C-7-4	5		66
215912	IT-C-7-4	5		66
216254	IT-C-7-4	5		82
216255	IT-C-7-4	5		82
216258	IT-C-7-4	5		83
216259	IT-C-7-4	5		83
216294	IT-C-7-4	5		82
216295	IT-C-7-4	5		82
216298	IT-C-7-4	5		83
216299	IT-C-7-4	5		83
216754		20		73
216755		20		73
216863	IT-C-7-3	20		56
216864	IT-C-7-3	20		56
216865	IT-C-7-3	20		62
216866	IT-C-7-3	20		62
216977	IT-C-7-3	20		71
217144		5		79
217145		5		79
217154	IT-C-7-4	5		80
217155	IT-C-7-4	5		80
217584	IT-A-1-9-8	20		103
217676	IT-C-7-3	20		64
218784	IT-C-7-4	5		66
218785	IT-C-7-4	5		66
218901	IT-C-7-2	20		55,61
218902	IT-C-7-2	20		55,61
218939	IT-C-7-3	20		51
218940	IT-C-7-3	20		51
218941	IT-C-7-3	20		58
218942	IT-C-7-3	20		58
218943	IT-C-7-3	20		53
218944	IT-C-7-3	20		53
218977	IT-A-6-2-9	100		48,100
218978	IT-A-6-2-9	100		48,100
219030	IT-C-7-4	5		80
219031	IT-C-7-4	5		80
219032		5		79
219033		5		79
219036	IT-C-7-2	20		72
219037	IT-C-7-2	20		72
219038	IT-C-7-4	5		72
219039	IT-C-7-4	5		72
219040	IT-C-7-4	5		72
219041	IT-C-7-4	5		72
219042	IT-C-7-4	5		72
219043	IT-C-7-4	5		72
219183	IT-C-7-2	20		71
219184	IT-C-7-2	20		71
219231	IT-C-7-2	20		50
219232	IT-C-7-2	20		50
219233	IT-C-7-2	20		57
219234	IT-C-7-2	20		57
219235	IT-C-7-2	20		53
219236	IT-C-7-2	20		53
219258	IT-C-7-2	20		64
219259	IT-C-7-2	20		64
219269	IT-C-7-3	20		75



No	Gruppo	 € (/00 = 100 pz.)	Pagina
219417	IT-C-7-4	5	79
219418	IT-C-7-4	5	79
219423	IT-C-7-4	5	79
219424	IT-C-7-4	5	79
219425	IT-C-7-4	5	79
219426	IT-C-7-4	5	79
219427	IT-C-7-4	5	79
219428	IT-C-7-4	5	79
219438	IT-C-7-4	5	81
219439	IT-C-7-4	5	81
219440	IT-C-7-4	5	81
219441	IT-C-7-4	5	81
219442	IT-C-7-4	5	83
219443	IT-C-7-4	5	83
219444	IT-C-7-4	10	81
219445	IT-C-7-4	5	81
219446	IT-C-7-4	5	81
219513	IT-C-7-5	20	86
219514	IT-C-7-5	20	86
219515	IT-C-7-5	20	86
219516	IT-C-7-5	20	86
219517	IT-C-7-5	20	86
219518	IT-C-7-5	20	86
219519	IT-C-7-5	20	87
219520	IT-C-7-5	20	87
219521	IT-C-7-5	20	87
219522	IT-C-7-5	20	87
219523	IT-C-7-5	20	87
219524	IT-C-7-5	20	87
219586	IT-C-7-4	5	80
219588	IT-C-7-4	5	80
219589	IT-C-7-4	5	80
219590	IT-C-7-4	5	80
219591		5	79
219592		5	79
219593	IT-C-7-4	5	79
219594	IT-C-7-4	5	79
219798	IT-C-7-4	5	79
219799	IT-C-7-4	5	79
219800	IT-C-7-4	5	79
219801	IT-C-7-4	5	79
219802	IT-C-7-4	5	79
219803	IT-C-7-4	5	79
221097	IT-C-7-5	20	87
222201	IT-A-6-1-1	50	48,100
224124	IT-C-7-5	20	86
224125	IT-C-7-5	20	86
224126	IT-C-7-5	20	86
224127	IT-C-7-5	20	86
224409	IT-C-7-2	20	75
224410	IT-C-7-2	20	75
224649	IT-C-7-4	5	66
224650	IT-C-7-4	5	66
224651	IT-C-7-4	5	66
224652	IT-C-7-4	5	66
224969	IT-C-7-2	20	73
224970	IT-C-7-2	20	73
224971	IT-C-7-4	5	74
224972	IT-C-7-4	5	74
224973	IT-C-7-4	5	74
224974	IT-C-7-4	5	74
224975	IT-C-7-4	5	74
224976	IT-C-7-4	5	74
225092	IT-A-6-2-9	20	48,100
226489	IT-C-7-2	20	64
226490	IT-C-7-2	20	64
226733		5	66
226734		5	66
227051	IT-C-7-1	5	94
227052	IT-C-7-1	5	94
227053	IT-C-7-1	5	94
227054	IT-C-7-1	5	94
227055	IT-C-7-1	5	94
227136	IT-C-7-4	5	80

No	Gruppo	 € (/00 = 100 pz.)	Pagina
227137	IT-C-7-4	5	80
227538	IT-S-1	20	96
228432	IT-C-7-8	10	97
228443	IT-C-7-2	20	75
228444	IT-C-7-2	20	75
228445	IT-C-7-3	20	75
228446	IT-C-7-3	20	75
228814	IT-C-7-3	20	74
228815	IT-C-7-3	20	74
228816	IT-C-7-2	20	74
228817	IT-C-7-2	20	74
228850	IT-C-7-3	20	76
228856	IT-C-7-3	20	72
230000	IT-C-4-1-3	5	35
230001	IT-C-4-1-3	5	35
230002	IT-C-4-1-3	5	35
230003	IT-C-4-1-3	5	35
230004	IT-C-4-1-3	5	35
230005	IT-C-4-1-3	5	35
230006	IT-C-4-1-3	5	35
230007	IT-C-4-1-3	5	35
230210	IT-C-4-1-6	5	35
230211	IT-C-4-1-6	5	35
230212	IT-C-4-1-6	5	35
230213	IT-C-4-1-6	5	35
230214	IT-C-4-1-6	5	35
230215	IT-C-4-1-6	5	35
230216	IT-C-4-1-6	5	35
230217	IT-C-4-1-6	5	35
230240	IT-C-4-2-3	5	35
230241	IT-C-4-2-3	5	35
230242	IT-C-4-2-3	5	35
230243	IT-C-4-2-3	5	35
230244	IT-C-4-2-3	5	35
230245	IT-C-4-2-3	5	35
230246	IT-C-4-2-3	5	35
230247	IT-C-4-2-3	5	35
230510		5	20
230511		5	20
230512		5	20
230513		5	20
230514		5	20
234170	IT-C-4-1-3	5	35
234171	IT-C-4-1-3	5	35
234420	IT-C-4-1-1	5	40
234421	IT-C-4-1-1	5	40
234422	IT-C-4-1-1	5	40
234423	IT-C-4-1-1	5	40
234424	IT-C-4-1-1	5	40
234425	IT-C-4-1-1	5	40
234426	IT-C-4-1-1	5	40
234427	IT-C-4-1-1	5	40
234480	IT-C-4-2-1	5	40
234481	IT-C-4-2-1	5	40
234482	IT-C-4-2-1	5	40
234483	IT-C-4-2-1	5	40
234484	IT-C-4-2-1	5	40
234485	IT-C-4-2-1	5	40
234486	IT-C-4-2-1	5	40
234487	IT-C-4-2-1	5	40
235090	IT-C-4-2-2	5	38
235092	IT-C-4-2-2	5	38
235093	IT-C-4-2-2	5	38
235094	IT-C-4-2-2	5	38
235095	IT-C-4-2-2	5	38
235096	IT-C-4-2-2	5	38
235097	IT-C-4-2-2	5	38
235790	IT-C-4-1-B	5	37
235791	IT-C-4-1-B	5	37
235792	IT-C-4-1-B	5	37
235793	IT-C-4-1-B	5	37
235794	IT-C-4-1-B	5	37
235795	IT-C-4-1-B	5	37
235796	IT-C-4-1-B	5	37



N^o	Gruppo		€ (/100 = 100 pz.)	Pagina
235797	IT-C-4-1-B	5		37
235830	IT-C-4-2-B	5		37
235831	IT-C-4-2-B	5		37
235832	IT-C-4-2-B	5		37
235833	IT-C-4-2-B	5		37
235834	IT-C-4-2-B	5		37
235835	IT-C-4-2-B	5		37
235836	IT-C-4-2-B	5		37
235837	IT-C-4-2-B	5		37
235870	IT-C-4-3-B	5		37
235871	IT-C-4-3-B	5		37
235872	IT-C-4-3-B	5		37
235873	IT-C-4-3-B	5		37
235874	IT-C-4-3-B	5		37
235875	IT-C-4-3-B	5		37
236570	IT-C-4-4-7	5		38
236571	IT-C-4-4-7	5		38
236572	IT-C-4-4-7	5		38
236573	IT-C-4-4-7	5		38
236574	IT-C-4-4-7	5		38
237210	IT-C-9	5		28
237211	IT-C-9	5		28
237212	IT-C-9	5		28
237213	IT-C-9	5		28
237214	IT-C-9	5		28
23731	IT-A-1-9-4	100		59
237310	IT-C-9	5		28
237311	IT-C-9	5		28
237312	IT-C-9	5		28
237313	IT-C-9	5		28
237314	IT-C-9	5		28
237360	IT-C-9	5		26
237361	IT-C-9	5		26
237362	IT-C-9	5		26
237363	IT-C-9	5		26
237364	IT-C-9	5		26
237490	IT-C-9	5		27
237491	IT-C-9	5		27
237492	IT-C-9	5		27
237493	IT-C-9	5		27
237494	IT-C-9	5		27
237610	IT-C-4-3-B	5		38
237611	IT-C-4-3-B	5		38
237612	IT-C-4-3-B	5		38
237613	IT-C-4-3-B	5		38
237614	IT-C-4-3-B	5		38
237615	IT-C-4-3-B	5		38
237616	IT-C-4-3-B	5		38
237617	IT-C-4-3-B	5		38
238550	IT-C-4-1-C	5		36
238551	IT-C-4-1-C	5		36
238552	IT-C-4-1-C	5		36
238553	IT-C-4-1-C	5		36
238554	IT-C-4-1-C	5		36
238555	IT-C-4-1-C	5		36
238557	IT-C-4-1-C	5		36
238600	IT-C-4-1-4	5		39
238601	IT-C-4-1-4	5		39
238602	IT-C-4-1-4	5		39
238603	IT-C-4-1-4	5		39
238604	IT-C-4-1-4	5		39
238605	IT-C-4-1-4	5		39
238606	IT-C-4-1-4	5		39
238607	IT-C-4-1-4	5		39
238750	IT-C-4-2-4	5		39
238751	IT-C-4-2-4	5		39
238752	IT-C-4-2-4	5		39
238753	IT-C-4-2-4	5		39
238754	IT-C-4-2-4	5		39
238755	IT-C-4-2-4	5		39
238756	IT-C-4-2-4	5		39
238757	IT-C-4-2-4	5		39
23883	IT-A-1-9-4	100		52
23886	IT-A-1-9-4	100		59

N^o	Gruppo		€ (/100 = 100 pz.)	Pagina
239030	IT-C-9	5		25
239031	IT-C-9	5		25
239032	IT-C-9	5		25
239033	IT-C-9	5		25
239034	IT-C-9	5		25
239035	IT-C-9	5		25
239036	IT-C-9	5		25
239037	IT-C-9	5		25
239080	IT-C-9	5		25
239081	IT-C-9	5		25
239082	IT-C-9	5		25
239083	IT-C-9	5		25
239084	IT-C-9	5		25
239085	IT-C-9	5		25
239086	IT-C-9	5		25
239087	IT-C-9	5		25
239130	IT-C-9	5		25
239131	IT-C-9	5		25
239132	IT-C-9	5		25
239133	IT-C-9	5		25
239134	IT-C-9	5		25
239135	IT-C-9	5		25
239136	IT-C-9	5		25
239137	IT-C-9	5		25
239180	IT-C-9	5		26
239181	IT-C-9	5		26
239182	IT-C-9	5		26
239183		5		26
239184	IT-C-9	5		26
239185	IT-C-9	5		26
239186	IT-C-9	5		26
239187	IT-C-9	5		26
239230	IT-C-9	5		26
239231	IT-C-9	5		26
239232	IT-C-9	5		26
239233	IT-C-9	5		26
239234	IT-C-9	5		26
239235	IT-C-9	5		26
239236	IT-C-9	5		26
239237	IT-C-9	5		26
239280	IT-C-9	5		26
239281		5		26
239282	IT-C-9	5		26
239283		5		26
239284		5		26
239285	IT-C-9	5		26
239286	IT-C-9	5		26
239287		5		26
239310	IT-C-9	5		27
239311	IT-C-9	5		27
239312	IT-C-9	5		27
239313	IT-C-9	5		27
239314	IT-C-9	5		27
239360	IT-C-9	5		27
239361	IT-C-9	5		27
239362	IT-C-9	5		27
239363	IT-C-9	5		27
239364	IT-C-9	5		27
239365	IT-C-9	5		27
239367	IT-C-9	5		27
239410	IT-C-9	5		28
239411	IT-C-9	5		28
239412	IT-C-9	5		28
239413	IT-C-9	5		28
239414	IT-C-9	5		28
239415	IT-C-9	5		28
239416	IT-C-9	5		28
239417	IT-C-9	5		28
239460	IT-C-9	5		27
239461	IT-C-9	5		27
239462	IT-C-9	5		27
239463	IT-C-9	5		27
239464	IT-C-9	5		27
239465	IT-C-9	5		27



N ^o	Gruppo	 € (/00 = 100 pz.)	Pagina
239466	IT-C-9	5	27
239467	IT-C-9	5	27
239950	IT-C-4-1-E	5	36
239951	IT-C-4-1-E	5	36
239952	IT-C-4-1-E	5	36
239953	IT-C-4-1-E	5	36
239954	IT-C-4-1-E	5	36
239955	IT-C-4-1-E	5	36
239956	IT-C-4-1-E	5	36
239957	IT-C-4-1-E	5	36
239960	IT-C-4-1-7	5	39
239961	IT-C-4-1-7	5	39
239962	IT-C-4-1-7	5	39
239963	IT-C-4-1-7	5	39
239964	IT-C-4-1-7	5	39
239965	IT-C-4-1-7	5	39
239966	IT-C-4-1-7	5	39
245420	IT-C-B-1-1	5	17
245421	IT-C-B-1-1	5	17
245422	IT-C-B-1-1	5	17
245423	IT-C-B-1-1	5	17
245424	IT-C-B-1-1	5	17
245425	IT-C-B-1-1	5	17
245426	IT-C-B-1-1	5	17
245427	IT-C-B-1-1	5	17
245428	IT-C-B-1-1	5	17
245432		5	18
245434	IT-C-B-1-2	5	18
245435	IT-C-B-1-2	5	18
245436	IT-C-B-1-2	5	18
245437	IT-C-B-1-2	5	18
245438	IT-C-B-1-2	5	18
245440	IT-C-B-1-3	5	18
245441	IT-C-B-1-3	5	18
245442	IT-C-B-1-3	5	18
245444	IT-C-B-1-3	5	18
245450	IT-C-B-1-3	5	19
245451	IT-C-B-1-3	5	19
245452	IT-C-B-1-3	5	19
245453	IT-C-B-1-3	5	19
245454	IT-C-B-1-3	5	19
245455	IT-C-B-1-3	5	19
245456	IT-C-B-1-3	5	19
245457	IT-C-B-1-3	5	19
245458	IT-C-B-1-3	5	19
245460	IT-C-B-1-4	5	20
245461	IT-C-B-1-4	5	20
245462	IT-C-B-1-4	5	20
245463	IT-C-B-1-4	5	20
245464	IT-C-B-1-4	5	20
245480	IT-C-B-1-1	5	17
245481	IT-C-B-1-1	5	17
245482	IT-C-B-1-1	5	17
245483	IT-C-B-1-1	5	17
245484	IT-C-B-1-1	5	17
245485	IT-C-B-1-1	5	17
245486	IT-C-B-1-1	5	17
245487	IT-C-B-1-1	5	17
245488	IT-C-B-1-1	5	17
245492	IT-C-B-1-2	5	18
245494	IT-C-B-1-2	5	18
245495	IT-C-B-1-2	5	18
245496	IT-C-B-1-2	5	18
245497	IT-C-B-1-2	5	18
245498	IT-C-B-1-2	5	18
245920	IT-C-B-1-3	5	19
245921	IT-C-B-1-3	5	19
245922	IT-C-B-1-3	5	19
245924	IT-C-B-1-3	5	19
245930	IT-C-B-1-3	5	19
245931	IT-C-B-1-3	5	19
245932	IT-C-B-1-3	5	19
245933	IT-C-B-1-3	5	19
245934	IT-C-B-1-3	5	19

N ^o	Gruppo	 € (/00 = 100 pz.)	Pagina
245935	IT-C-B-1-3	5	19
245936	IT-C-B-1-3	5	19
245937		5	19
245938		5	19
245940		5	20
245941		5	20
245942		5	20
245943		5	20
245944		5	20
245960		5	17
245961		5	17
245962		5	17
245963		5	17
245964	IT-C-B-1-1	5	17
245965	IT-C-B-1-1	5	17
245966		5	17
245967		5	17
245968		5	17
245972	IT-C-B-1-2	5	18
245974		5	18
245975		5	18
245976		5	18
245977		5	18
245978		5	18
245980	IT-C-B-1-3	5	19
245981	IT-C-B-1-3	5	19
245982	IT-C-B-1-3	5	19
245984		5	19
245990		5	20
245991		5	20
245992		5	20
245993		5	20
245994		5	20
245995		5	20
245996		5	20
245997		5	20
245998		5	20
26617	IT-C-7-3	20	59
26755	IT-A-1-9-4	100	59
26799	IT-C-7-3	20	52
28603	IT-S-1	1	107
29776	IT-C-7-2	50	50
29787	IT-C-7-2	50	53,60

3

30545	IT-A-1-9-1	200	50
34004	IT-C-7-3	50	53
34606	IT-A-1-9-1	200	64
34610	IT-A-1-9-1	200	64
34934	IT-A-1-9-1	200	61
34943	IT-A-1-9-1	200	57
34969	IT-A-1-9-1	200	57
34979	IT-A-1-9-1	200	57
34980	IT-A-1-9-1	200	57
34981	IT-A-1-9-1	200	60
35250	IT-C-7-3	50	65
354358	IT-C-7-6	100	101
354952	IT-C-7-2	20	50
354954	IT-C-7-2	20	50
354987	IT-C-7-3	20	64
355000	IT-C-7-3	20	64
356361	IT-A-1-9-8	100	75
356362	IT-A-1-9-1	200	75
357671	IT-A-1-9-1	200	55
357672	IT-A-1-9-1	200	55
357673	IT-A-1-9-8	100	55
357674	IT-A-1-9-8	100	55
358024	IT-C-7-3	50	102
360074	IT-C-7-6	100	101
360102	IT-A-1-9-8	100	55
360103	IT-A-1-9-8	100	55
360112	IT-C-7-2	20	50
360113	IT-C-7-2	20	50
360159	IT-C-7-6	20	101



No	Gruppo		€ (/100 = 100 pz.)	Pagina
360397	IT-C-7-6	50		72,102
360614	IT-C-7-2	20		55
360615	IT-C-7-2	20		55
360693	IT-A-1-9-1	200		76
360694	IT-A-1-9-8	100		76
361453	IT-C-7-3	100		75
362002	IT-C-7-3	20		51,54
362704	IT-C-7-6	100		102
362906	IT-C-7-8	50		103
362920	IT-C-7-6	100		101
363322	IT-C-7-3	20		53
363473	IT-C-B-3	1		96
363959	IT-C-7-6	100		72,102
364326	IT-C-7-6	100		72,102
364770	IT-C-7-7	20		102
364771	IT-C-7-7	20		102
364952	IT-A-1-9-8	100		61
364953	IT-A-1-9-8	100		61
367505	IT-A-1-9-8	20		103
367701	IT-C-B-3	1		96
367702	IT-C-B-3	1		96
367722	IT-A-1-9-8	20		103
367738	IT-A-1-9-8	20		103
368014	IT-A-1-9-8	20		103
38924	IT-C-7-3	50		59

4

40720	IT-S-1	20		102
43524	IT-C-7-2	50		102
43586	IT-C-7-8	50		103
43718	IT-A-1-B-9	100		101
44205	IT-A-1-B-8	100		101
44206	IT-A-1-B-8	100		101
44253	IT-C-7-6	50		101
44268	IT-A-1-B-8	100		101
44372	IT-C-7-6	50		101
44373	IT-C-7-6	50		101
453541	IT-U-5	1		102
456229	IT-C-7-8	1		103
456348	IT-C-7-8	1		103
456351	IT-C-7-8	1		103
456353	IT-C-7-8	1		103
457573	IT-C-7-5	20		86
458274	IT-C-B-3	1		96
460342	IT-C-7-6	100		101
461742	IT-S-1	1		106
463097	IT-C-7-8	1		103
463098	IT-C-7-8	1		103
463268	IT-S-1	1		106
463269	IT-S-1	1		106
463946	IT-S-1	1		106
463947	IT-S-1	1		106
466699	IT-C-B-3	1		95
466833	IT-C-B-3	1		96
466834	IT-C-B-3	1		96
466835	IT-C-B-3	1		96
466836	IT-C-B-3	1		96
466837	IT-C-B-3	1		96
466838	IT-C-B-3	1		96
466842	IT-C-B-3	1		96
467734	IT-S-1	1		106
476513	IT-C-B-3	1		95
476514	IT-C-B-3	1		95
476515	IT-C-B-3	1		95
478065	IT-C-B-3	1		95
478181	IT-C-B-3	5		95

5

50576	IT-C-7-3	20		52
50579	IT-C-7-3	20		59,74
55049	IT-A-1-7-3-1	20		80
55112	IT-A-1-9-4	100		52
55252	IT-C-7-3	50		59
55985	IT-C-7-5	20		86,87,88
55986	IT-C-7-3	20		59

No	Gruppo		€ (/100 = 100 pz.)	Pagina
55987	IT-C-7-2	50		57
55989	IT-C-7-5	20		86,87,88
55992	IT-C-7-1	10		92
55993	IT-C-7-1	10		92
57824	IT-C-7-1	10		92
57825	IT-C-7-1	10		92
57826	IT-C-7-1	10		92
57827	IT-C-7-1	10		92
57915	IT-T-1	20		89
57916	IT-T-1	20		89
58029	IT-T-1	20		89
58030	IT-T-1	20		89
58107	IT-C-7-1	10		92
58333	IT-C-7-1	10		92
58335	IT-C-7-1	10		93
58452	IT-C-1-2	5		43
58453	IT-C-1-2	5		43
58455	IT-C-1-2	5		43
58456	IT-C-1-2	5		43
58457	IT-C-1-2	5		43
58458	IT-C-7-1	10		92
58461	IT-C-1-2	5		43
58462	IT-C-1-2	5		43
58463	IT-C-7-5	20		86
58464	IT-C-7-5	20		86,87,88
58465	IT-T-1	20		89
58467	IT-C-7-5	20		86
58468	IT-C-7-5	20		86,87,88
58469	IT-T-1	20		89
58574	IT-C-7-5	20		87
58575	IT-C-7-5	20		87
58608	IT-C-7-5	20		87
58609	IT-C-7-5	20		87
58646	IT-C-7-2	50		57
58647	IT-C-7-2	50		57
58648	IT-C-7-2	20		57
58649	IT-C-7-2	20		57
58667	IT-C-7-3	20		59
58674	IT-C-7-2	50		64
58675	IT-C-7-2	50		64
58714	IT-C-7-2	50		64
58715	IT-C-7-2	50		64
59420	IT-C-7-2	10		50
59421	IT-C-7-2	50		50
59422		20		86
59423		20		86
59424	IT-C-7-5	20		86
59425	IT-C-7-5	20		86
59426	IT-C-7-5	20		87
59427	IT-C-7-5	20		87
59428	IT-C-7-5	20		87
59429	IT-C-7-5	20		87
59430	IT-C-7-5	20		87
59431	IT-C-7-5	20		87

9

94019	IT-A-1-B-9	10		102
94118	IT-C-7-3	50		52
94219	IT-A-1-B-9	100		102
94322	IT-C-7-3	50		59
94463	IT-A-1-9-1	200		64
96263	IT-A-1-9-8	100		58
96264	IT-A-1-9-8	100		58
96305	IT-A-1-9-8	100		51
96306	IT-A-1-9-8	100		51
96558	IT-A-1-9-8	100		64
96561	IT-A-1-9-8	100		60
96563	IT-A-1-9-8	100		58
96564	IT-A-1-9-8	100		58
96565	IT-A-1-9-8	100		51
96566	IT-A-1-9-8	100		51
96660	IT-A-1-9-8	100		58
96845	IT-A-1-9-8	100		53
96846	IT-A-1-9-8	100		53



N°	Gruppo		€	Pagina
			(/100 = 100 pz.)	
96860	IT-A-1-9-8	100		58
96861	IT-A-1-9-8	100		60
K				
K702501	IT-U-4-2	1		57
K702505	IT-U-4-2	1		57
K705607	IT-U-4-2	1		57
K705608	IT-U-4-2	1		57
X				
X801920	IT-S-1	1		106
X804521	IT-S-1	1		106
X804522	IT-S-1	1		106
X804540	IT-S-1	1		106
X992204	IT-S-1	1		107